

Structural Testing

Part 1 · Mechanical Mobility Measurements

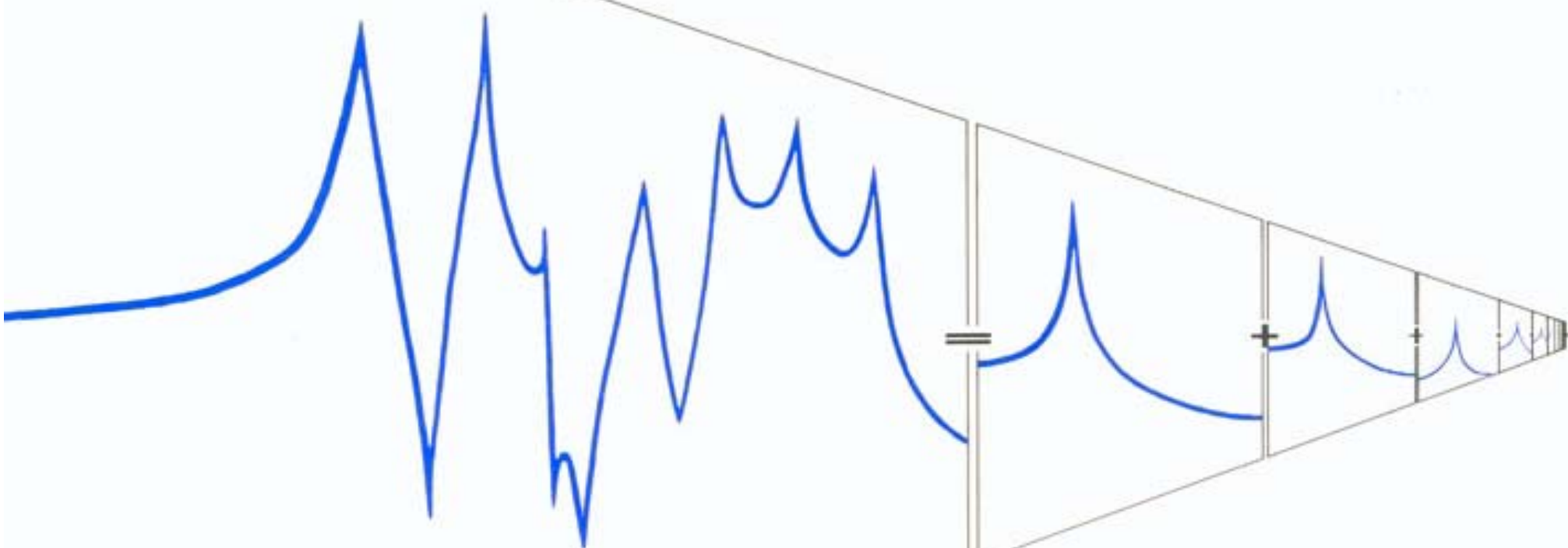

STRUCTURAL TESTING

Part I: Mechanical Mobility Measurements

By
Ole Døssing, Brüel & Kjær

See page	See page
Noise and Vibration: Cause and Effect 3	Excitation 26
Signal vs. System Analysis 5	Implementing the Excitation 28
Trouble-shooting 6	Response Measurements 30
Treating Dynamic Problems 8	Random Excitation 33
Modal Analysis 10	Pseudo-Random Excitation 34
Mathematical Dynamic Models 11	Impact Excitation 35
Application of Modal Data 12	Impact Testing and the Coherence Function 36
Verification of an Analytical Mathematical Model 13	Window Techniques for Impact Testing39
The Frequency Response Function 14	The Transient Window 40
Mobility Measurements-Definitions 16	The Response Window 41
Estimation of the FRF 17	Comparison between Excitation Forms 42
The Dual Channel FFT Analyzer 21	Calibration 43
Errors..... 23	Case History: Vibrations in a Gantry Crane 45
Choice of Optimal FRF Estimator 25	

Preface

A comprehensive understanding of structural dynamics is essential to the design and development of new structures, and to solving noise and vibration problems on existing structures.

Modal analysis is an efficient tool for describing, understanding, and modeling structural behaviour. The study of modal analysis is an excellent means of attaining a solid understanding of structural dynamics.

Structural Testing consists of a comprehensive introduction to the theoretical background to modal analysis and structural dynamics. If the text is read and truly understood, we believe that the student, armed with a simple set of measurements and an intelligent interpretation, will be able to solve around 90% of noise and vibration problems met with in industry.

We have assumed that the reader is familiar with the fundamental techniques of vibration measurement and signal analysis. A clear distinction has been made between analytical and experimental approaches, while concentrating on the experimental techniques. Mathematics has been used only on a limited basis, and in support of intuitive introductions. Emphasis has been placed on the broadband testing technique, supported by dual-channel FFT analyzers, although the basic theory applies to any testing method.

Structural Testing is divided into two parts:

- Part 1: Mechanical Mobility Measurements
- Part 2: Modal Analysis and Simulation

Noise and Vibration: Cause and Effect

Noise and vibration in the environment or in industry are *caused* by particular processes where dynamic forces excite structures.

The *effects* of noise and vibration range from annoyance, fatigue and reduced comfort, to safety and even health hazards. On machines, vehicles and buildings the effect may be wear, reduced performance, faulty operation or any degree of irreversible damage.

Vibration and noise (defined here as unwanted sound) are closely related. Noise is simply part of the vibrational energy of a structure transformed into air pressure variations.

Most noise and vibration problems are related to resonance phenomena. Resonance occurs when the dynamic forces in a process excite the natural frequencies, or modes of vibration, in the surrounding structures. This is one reason for studying modes.

A second reason for studying modes is that they form the basis for a complete dynamic description of a structure.

• Does a problem exist?

Some level of noise and vibration will always be a side-effect of any dynamic process. Measurements of noise can be compared with international standards to determine whether they are within acceptable limits. In some cases, vibration measurements can be checked against the manufacturer's specification, but more often a vibration problem could be indicated by failure in a machine, or by poor performance.

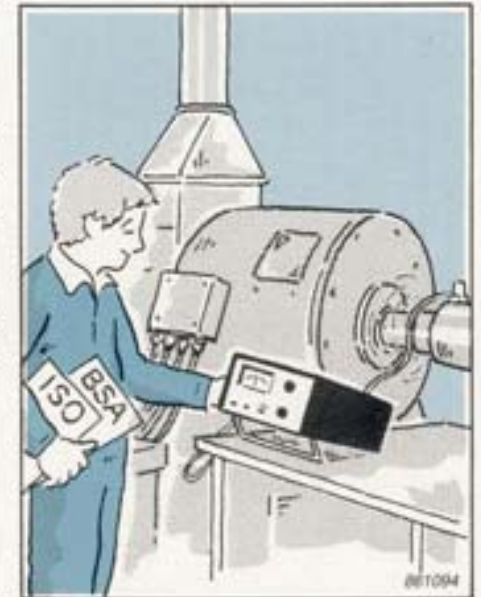

• Who is responsible for the problem?

If excessive noise or vibration levels are found, who is responsible for the problem?

In any given situation there are always three factors:

- Source - where the dynamic forces are generated
- Path - how the energy is transmitted
- Receiver - how much noise/vibration can be tolerated

Any of these may contain the cause of the problem, and can be investigated to find the corresponding optimal solution.

Consider a car driver who feels that the vehicle noise level is too high. In this case the source is the vehicle transmission, the path is the car body, and the receiver is the driver's ear.

It is unlikely that the driver's ear is too sensitive, although a symptomatic treatment of the ears - using ear protectors - is possible, though unacceptable. The problem is therefore limited to the car body and the transmission; who is responsible for the problem?

The designers of the car body, and the designers of the transmission may claim that their individual components behave satisfactorily. The fact remains that interaction between the components causes a serious problem.



Signal vs. System Analysis

Before setting out on our quest to solve noise and vibration problems, we must make a clear distinction between the two roads which can be followed, signal analysis and system analysis.

Signal analysis is the process of determining the response of a system, due to some generally unknown excitation, and of presenting it in a manner which is easy to interpret.

System analysis deals with techniques for determining the inherent properties of a system. This can be done by stimulating the system with measurable forces and studying the response/force ratio (sensitivity). For linear systems this ratio is an independent, inherent property which remains the same whether the system is excited or at rest.

The quality of your hi-fi system lies in its frequency characteristics, which are the same whether you play Bach or Beatles. The characteristics determine how well the set will reproduce the signal on the record.

Your car has the same mode shapes and natural frequencies whether it is parked in your garage or driving at 100 km/h on the highway. The modal parameters are a measure of the dynamic characteristics of the car, and determine the comfort and safety of your drive.

If you take any example of a linear system, it is the system characteristics which determine what *signal* we will sense from a process under some operating condition.

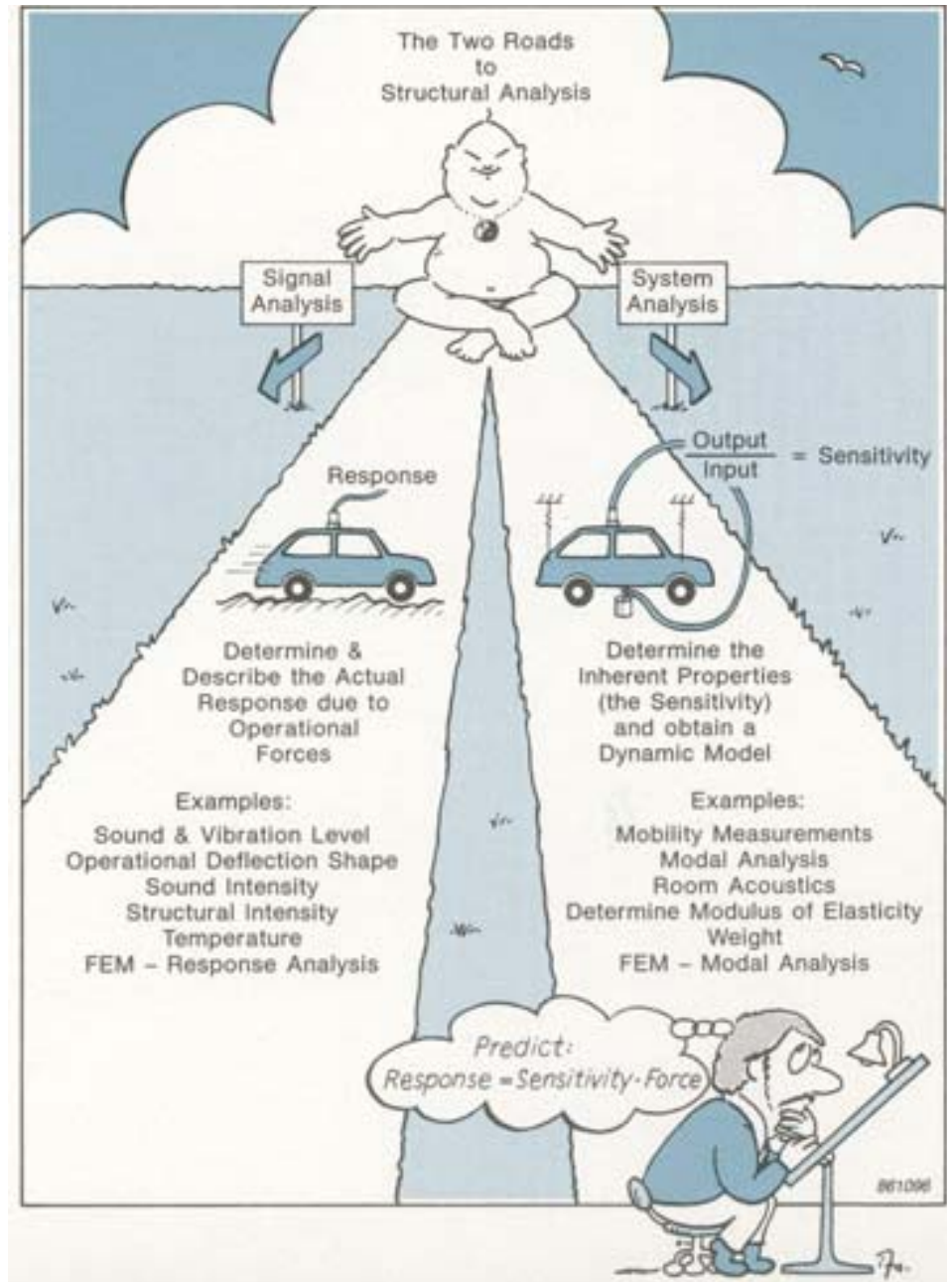

Trouble-shooting

• Signal analysis

Let us investigate what information can be obtained from the measurement, and analysis, of response signals from a car under operating conditions. We can mount an accelerometer somewhere inside the passenger compartment - possibly at the point that appears to radiate most of the noise.

Studying the acceleration time history does not give much helpful information. A transformation to the frequency domain yields the acceleration spectrum. This spectrum often has distinct features which might show that the energy is concentrated around one or more discrete frequencies (tones).

A knowledge of the system mechanics enables distinct frequency components to be related to specific mechanical components, thus identifying the source of the noise or vibration.

In our example, a discrete component in the acceleration spectrum may be found to correspond with the rotational speed of a particular shaft in the transmission system. This would give strong evidence that this component is the source of the vibration and noise.

Once the source has been located new questions arise:

"Does the source have a high level of free dynamic energy, forcing the structure to vibrate?"

Or

"Is the structure 'dynamically weak' or compliant, at this particular frequency, and responding excessively to other-wise normal forces?"

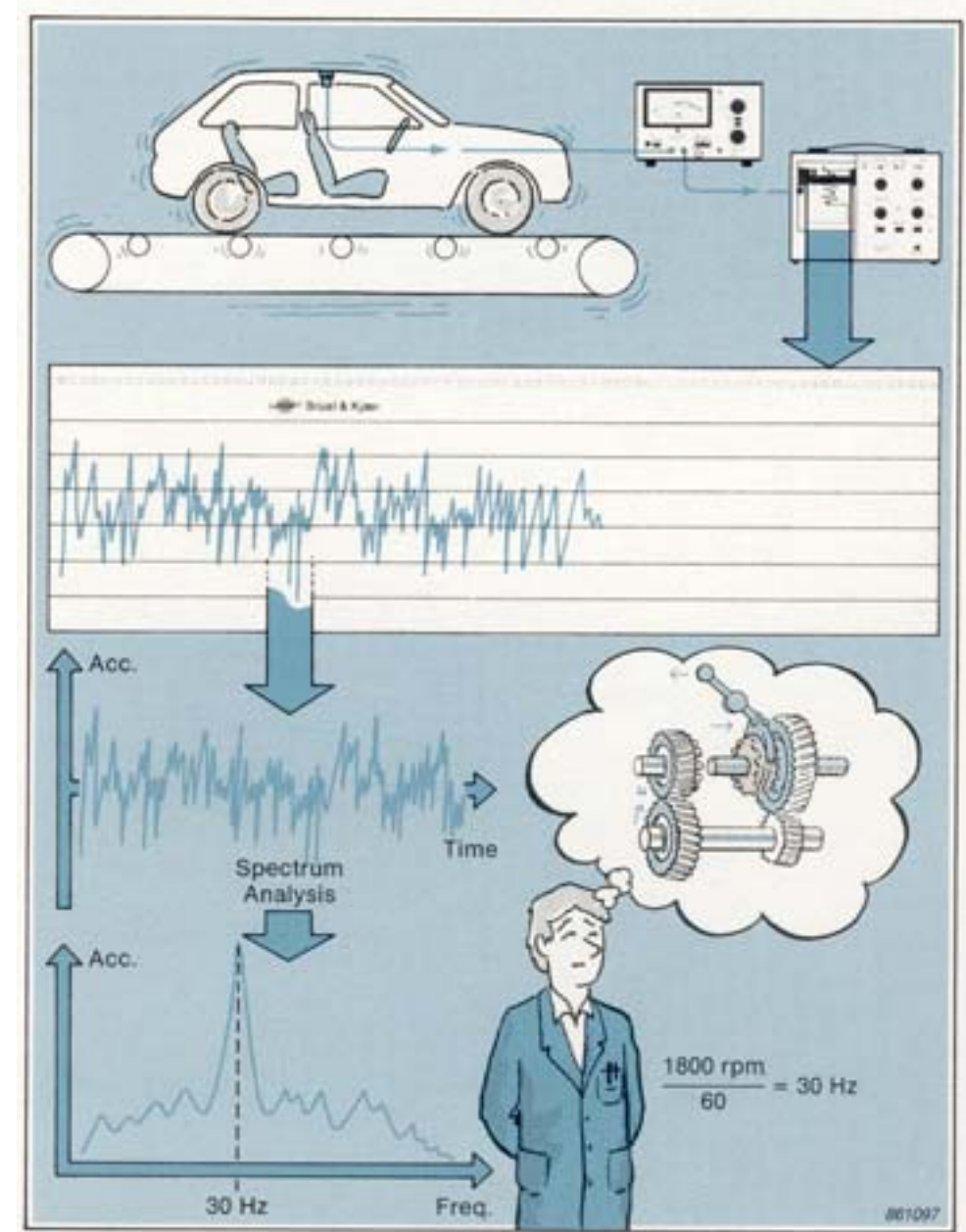

• System analysis

Once the vibration source has been located, we can concentrate on the system. The properties of the transmission path, between the source and receiver, represent the inherent dynamic characteristics of the combined systems.

A first step towards describing path properties is to make a run-up/coast-down test, during which the response (acceleration) is measured for different speeds. The response is then plotted against speed. This plot will give a qualitative indication of significant resonances in the operating frequency range, since excitation frequency is proportional to speed.

The run-up/coast-down technique can be extended to give three-dimensional plots. These can be plots of the spectrum vs. the speed (waterfall display), or the vibration level and frequency, for a number of harmonics, as a function of speed (Campbell diagrams).

If, as in our example, peaks are found in the plot of response vs. speed, then it is reasonable to conclude that resonances exist in the system. However, since the forcing function is unknown, this conclusion is not necessarily correct. The peaks may be present in the forcing function.

In the run-up/coast-down test, only the response to varying excitation frequency is measured, and the level of the excitation force varies without control. Our measurements can only therefore give coarse qualitative information about the system properties.

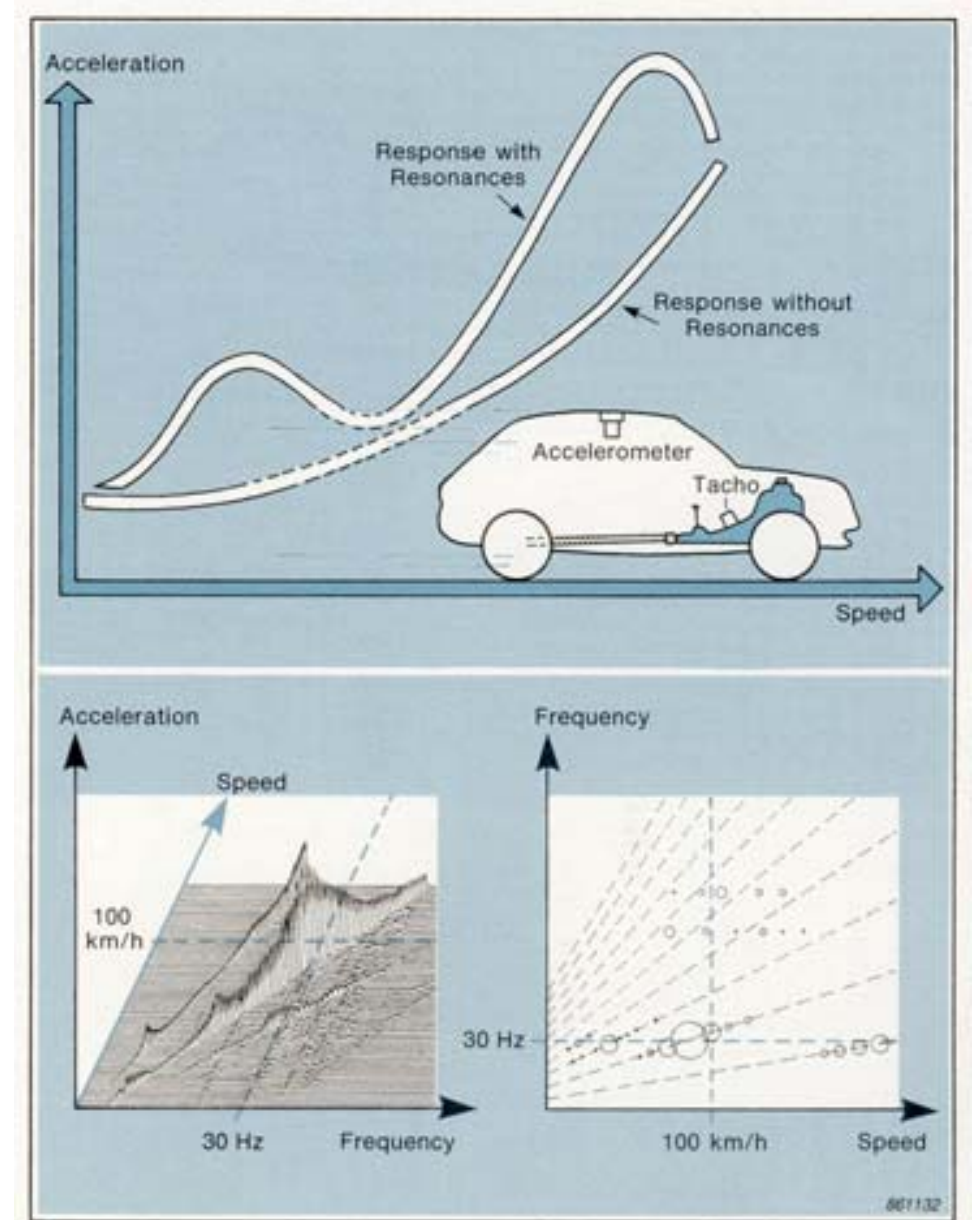

Treating Dynamic Problems

In order to treat the problem we must understand how the structure behaves dynamically. This means we must determine the deformation of the structure at the critical frequency. Once again we can choose one of two approaches:

- Signal analysis = operational deflection shape measurement
- System analysis = modal testing
- **Operational deflection shape measurement**

The aim of operational deflection shape measurement is to determine the *forced* dynamic deflection at the operating frequency.

The simplest and most accurate technique is to mount an accelerometer at some point as a reference; and then to attach a roving accelerometer at other points and, if necessary, in different directions. The measurement points should be chosen sufficiently closely spaced to obtain good spatial resolution. At all points, the magnitude and phase differences between the roving and reference accelerometers are measured during steady state operation. The instrumentation used can be two individual single-channel systems or a dual-channel FFT analyzer.

The measurements are then plotted to obtain an impression of how the individual parts of the structure move, both absolutely and in relation to each other.

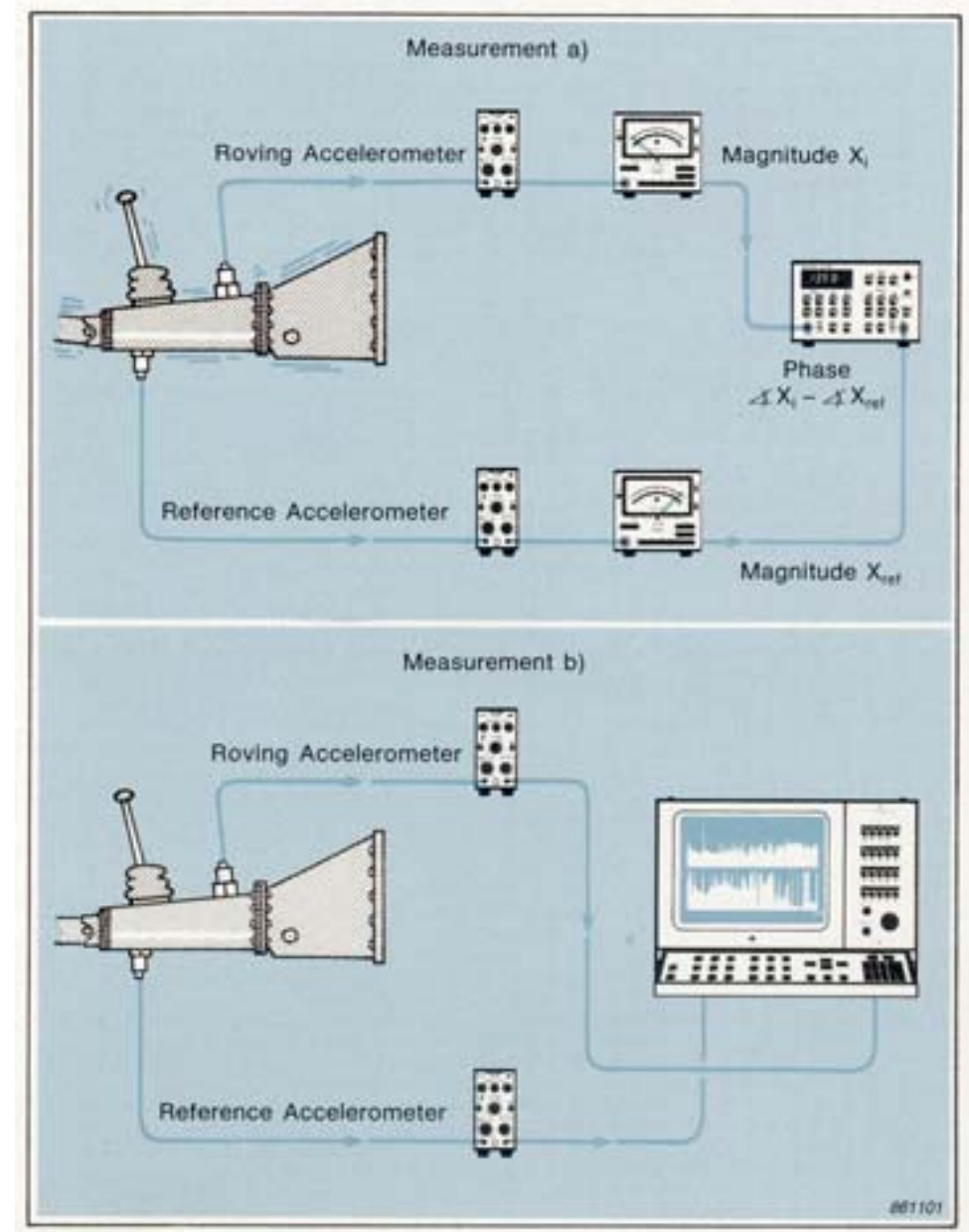

The operational deflection shape represents the absolute deflection of a structure due to the unknown but real forces. The deflection shape does not give any information about the independent dynamic properties of the system. Information cannot therefore be obtained about deflections due to other forces, or at other frequencies.

In our example, the deflection shape shows that the transmission system and the engine move in a vertical 'pitch' fashion. From this information it would appear that a good solution to the noise problem could be to constrain the transmission/engine against this motion. This could be done by adding some stiffness - optimally between the points where the deflection difference is greatest - where the points move with opposite phase.

The effect of the stiffening is that the natural frequency increases, hopefully beyond the operational frequency range. The amount of stiffening required can only be determined by trial and error, guided by engineering experience.

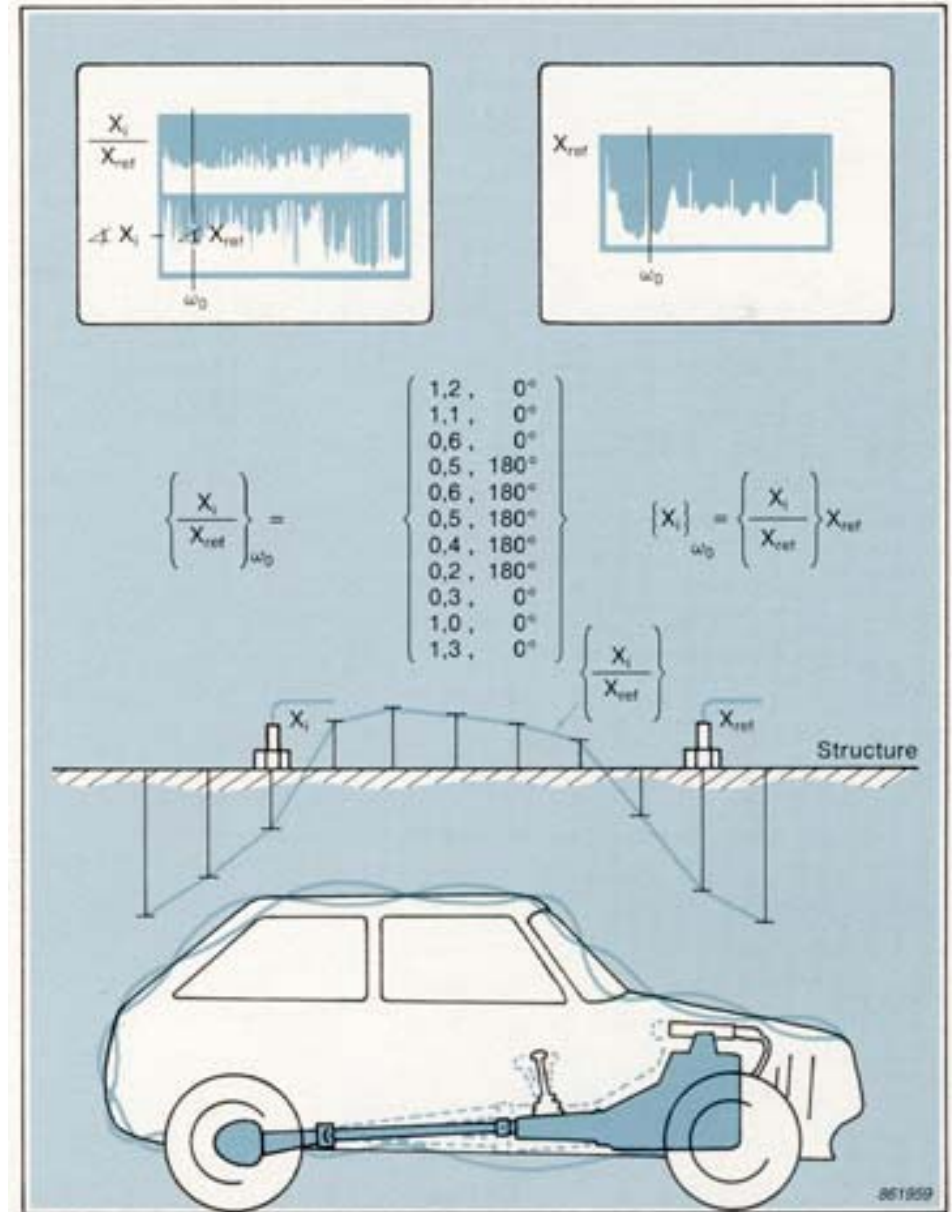

Modal Analysis

• Modal properties

Most practical noise and vibration problems are related to resonance phenomena, where the operational forces excite one or more of the modes of vibration. Modes of vibration which lie within the frequency range of the operational dynamic forces, always represent potential problems.

An important property of modes is that any forced or free dynamic response of a structure can be reduced to a discrete set of modes.

The modal parameters are:

- Modal frequency
- Modal damping
- Mode shape

The modal parameters of all the modes, within the frequency range of interest, constitute a complete dynamic description of the structure. Hence the modes of vibration represent the inherent dynamic properties of a *free* structure (a structure on which there are no forces acting).

Modal analysis is the process of determining all the modal parameters, which are then sufficient for formulating a mathematical dynamic model. Modal analysis may be accomplished either through analytical or experimental techniques.

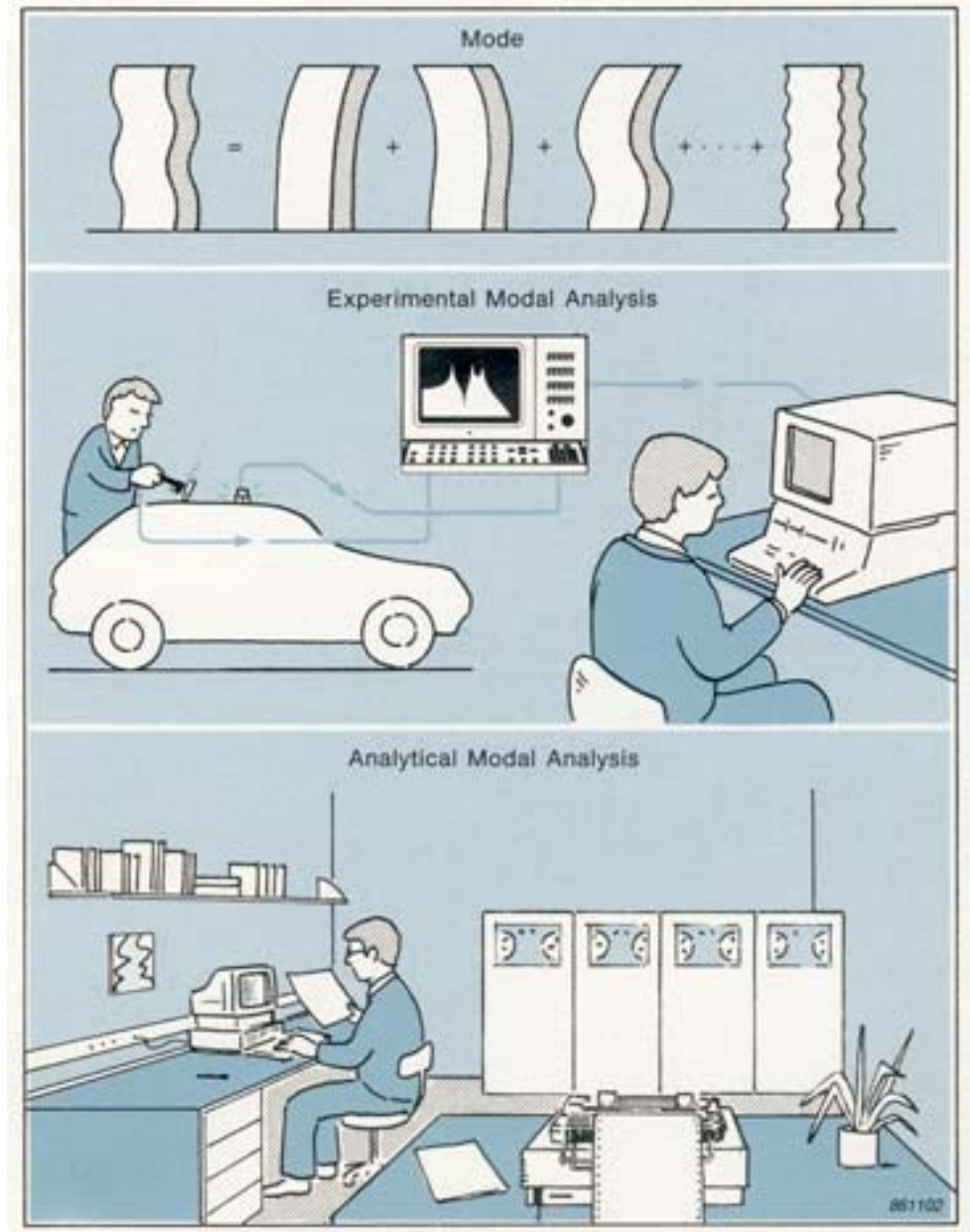

Mathematical Dynamic Models

Mathematical models are desired, or are necessary, for a number of reasons:

- To understand and communicate how structures behave under dynamic loads,
- To use in data reduction and smoothing techniques (curve fitting),
- To simulate or predict the response to assumed external forces,
- To simulate changing dynamic characteristics, due to physical modifications.

Mathematical models are generally not models of the structure itself. Rather they are models of the structure's dynamic behaviour, constrained by a set of assumptions and boundary conditions.

Analytical mathematical models are based on calculated mass and stiffness distributions of a specific set of boundary conditions. These calculations are usually made by the Finite Element Method (FEM), and the model produces an enormous set of *coupled* differential equations, which can only be solved by using large computers.

Experimental mathematical models can be constructed from measured modal data, which represent the system under the measured conditions. The model normally consists of a set of *independent* differential equations, one for each mode in the measurement. This model is often referred to as the "Modal Model".

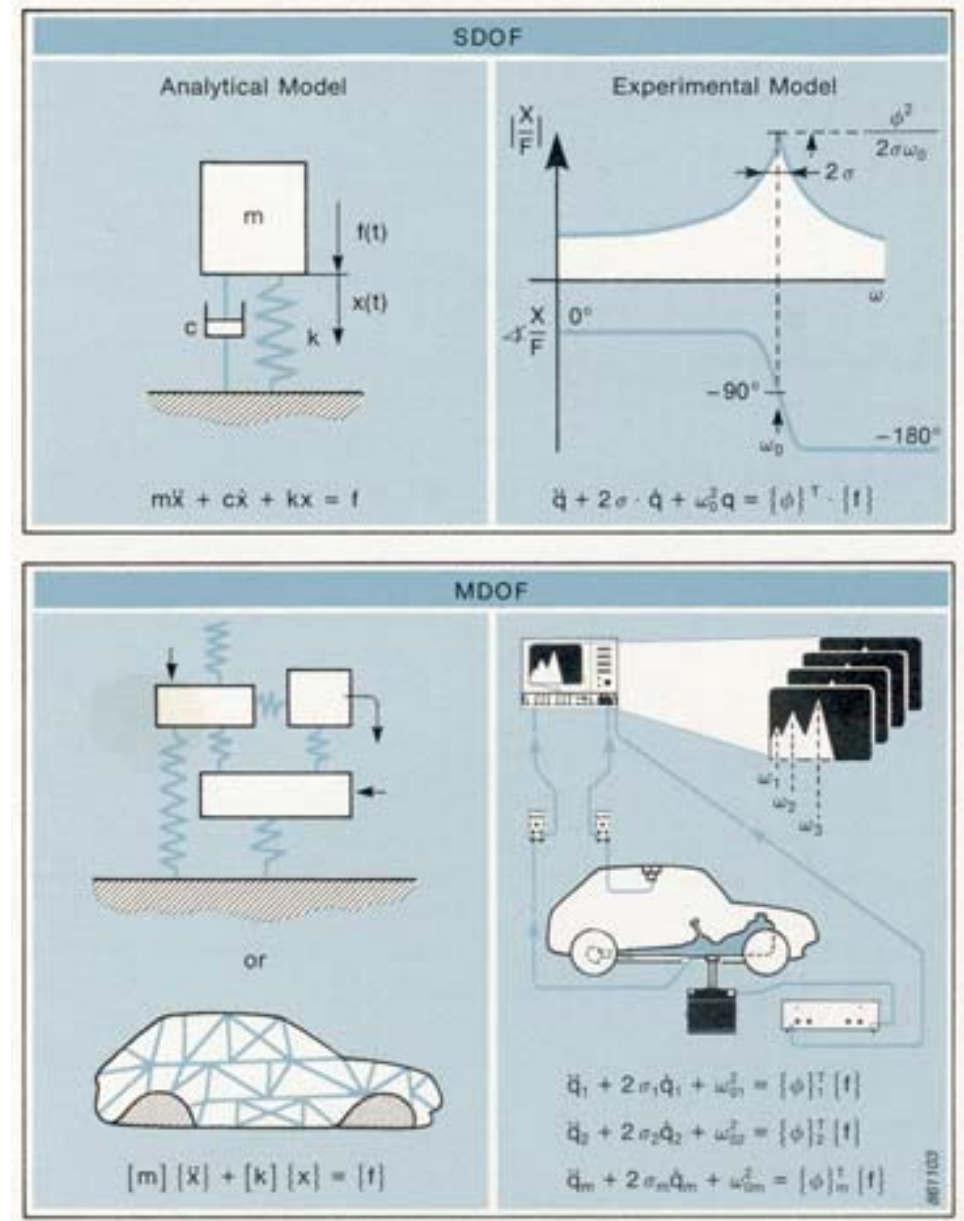

Application of Modal Data

We shall now look at the application of modal data obtained through experimental modal analysis.

The result of an experimental modal test may be of any degree of sophistication ranging from:

- A single Frequency Response Measurement (FRF) showing weak structural dynamic conditions in terms of modal frequencies, to a set of FRF measurements giving modal frequencies and the associated mode shapes;
- The mode shape data and subsequent animation of the mode shapes, to the creation of a concise mathematical dynamic modal model.

The range of applications for modal data is vast and includes:

- Checking modal frequencies
- Forming qualitative descriptions of the mode shapes - as an aid to understanding dynamic structural behaviour for trouble-shooting
- Verifying and improving analytical models
- Making computer simulations (based on the modal model) for prototype development, or advanced trouble-shooting, where we need to:
 - Predict the response to assumed excitations, and check the dynamic performance
 - Predict the change in dynamic properties due to physical modifications, such as adding payload, or stiffness.
 - Predict the necessary physical modifications required to obtain a desired dynamic property
 - Predict the combined behaviour when two or more structures are coupled together as a unit.

Verification of an Analytical Mathematical Model

As an example, we will examine the design stages for a skyscraper, a building designed to withstand earthquakes and complex wind loads.

An analytical mathematical model is first created and loaded with the design forces. The results show satisfactory dynamic behaviour.

After the building is constructed, the design must be proved. The mathematical model contains some ideal inertia and stiffness distributions, which cannot be measured directly. A "full-scale" test is out of the question, so what can be done?

Modal analysis on both the structure and the model provides the solution. The top of the building is excited by an attached electrodynamic shaker, or an eccentric mass exciter. A known force is then applied, in the frequency range of interest, and the response measured at a number of selected points. From these measurements the modal parameters are determined.

The modal parameters found from both analytical and experimental methods are directly comparable. If the results do not agree, the analytical model is adjusted and refined until sufficient agreement is achieved. Finally, the analytical computations are repeated with the modified model, and the response to the design forces can then be predicted.

If the analytical dynamic behaviour satisfies the design criteria, the results are then considered to be proof of safe dynamic properties for the skyscraper.

The analytical model also provides the means for evaluating the comfort of the occupants of the building. Any suggested dynamic improvements may then be simulated and refined.

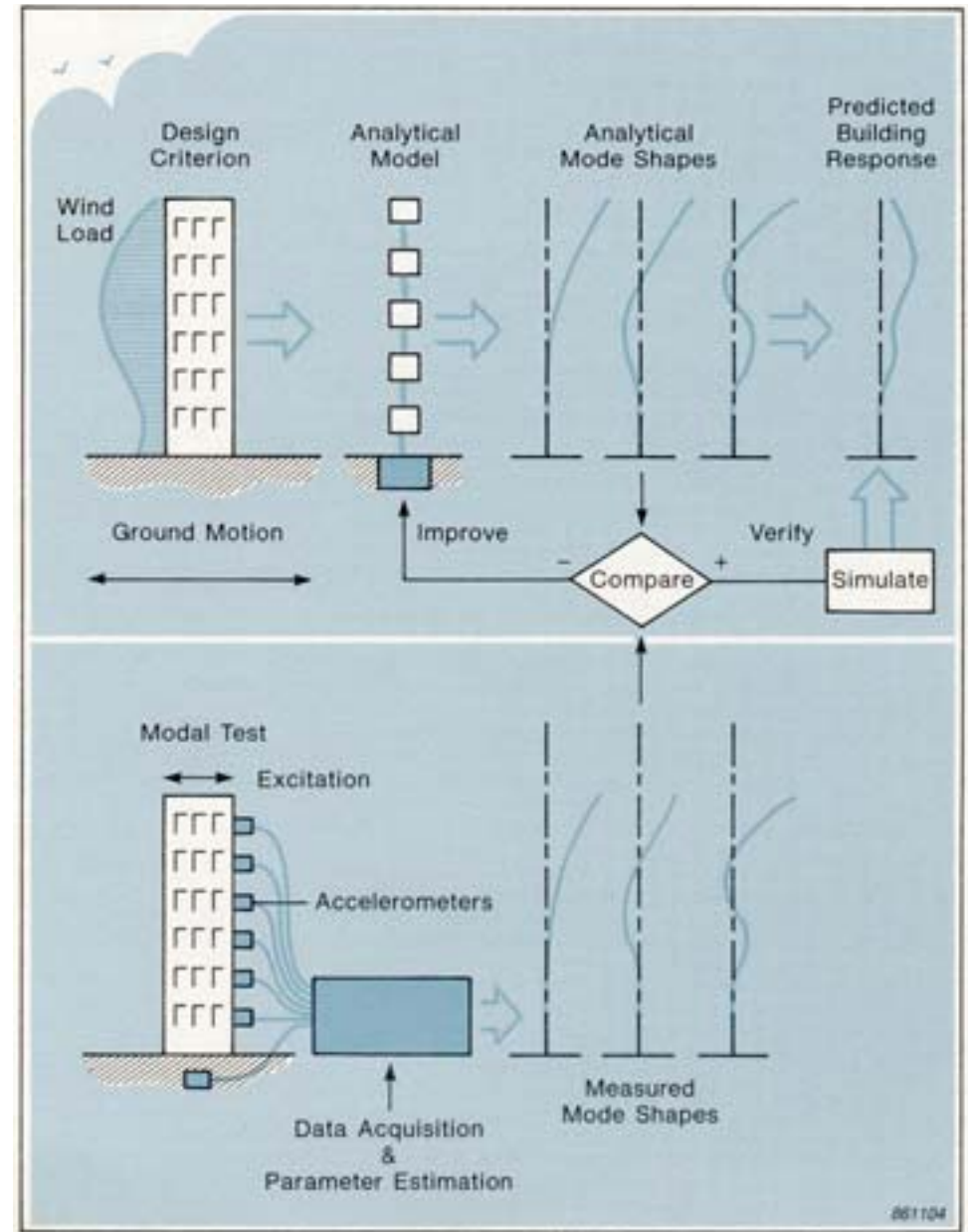

The Frequency Response Function

One very efficient model of a linear system is a frequency domain model, where the output spectrum is expressed as the input spectrum weighted by a system descriptor

$$X(\omega) = H(\omega) \cdot F(\omega)$$

This system descriptor $H(\omega)$ is called the Frequency Response Function (FRF), and is defined as:

$$H(\omega) \equiv \frac{X(\omega)}{F(\omega)}$$

It represents the complex ratio between output and input, as a function of frequency ω . By complex we mean that the function has a magnitude $|H(\omega)|$ and a phase $\angle H(\omega) = \phi(\omega)$.

The physical interpretation of the FRF is that a sinusoidal input force, at a frequency ω , will produce a sinusoidal output motion at the same frequency. The output amplitude will be multiplied by $|H(\omega)|$, and the phase, between output and input, will be shifted by $\angle H(\omega)$.

As we have limited ourselves to dealing with linear systems, any input/output spectrum can be considered to be the sum of sinusoids. The FRF describes the dynamic properties of a system independent of the signal type used for the measurement. The FRF is therefore equally applicable to harmonic, transient and random excitation.

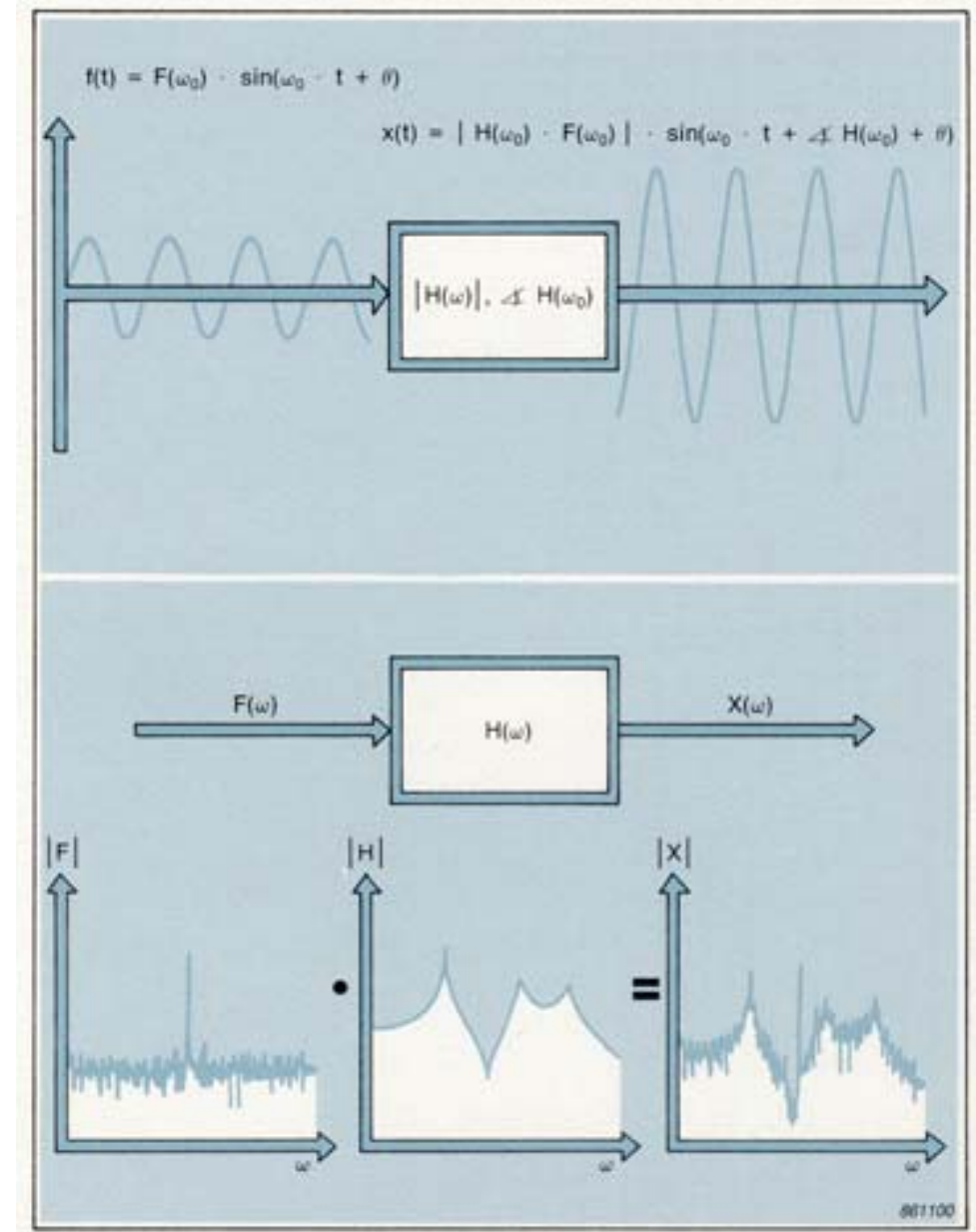

The definition of the FRF means that, in measuring a specific function, the measurements can be made sequentially at discrete frequencies or simultaneously at several frequencies. A useful technique is to use a wide frequency bandwidth for the excitation force. This gives a dramatic reduction in measurement time, as compared to sinusoidal excitation where one frequency is measured at a time.

In our example of an FRF measurement, between the reference accelerometer and the excitation force at the gearbox, there is a second natural frequency close to the 30 Hz operational shaft speed. This leads to dynamic amplification of the response, and results in the high noise level in the passenger compartment.

Resonances in the operational frequency range may be considered as structural weaknesses. The severity of a resonance depends on the magnitude of the FRF between the point where the operational forces act on the structure, and the point where the response is observed.

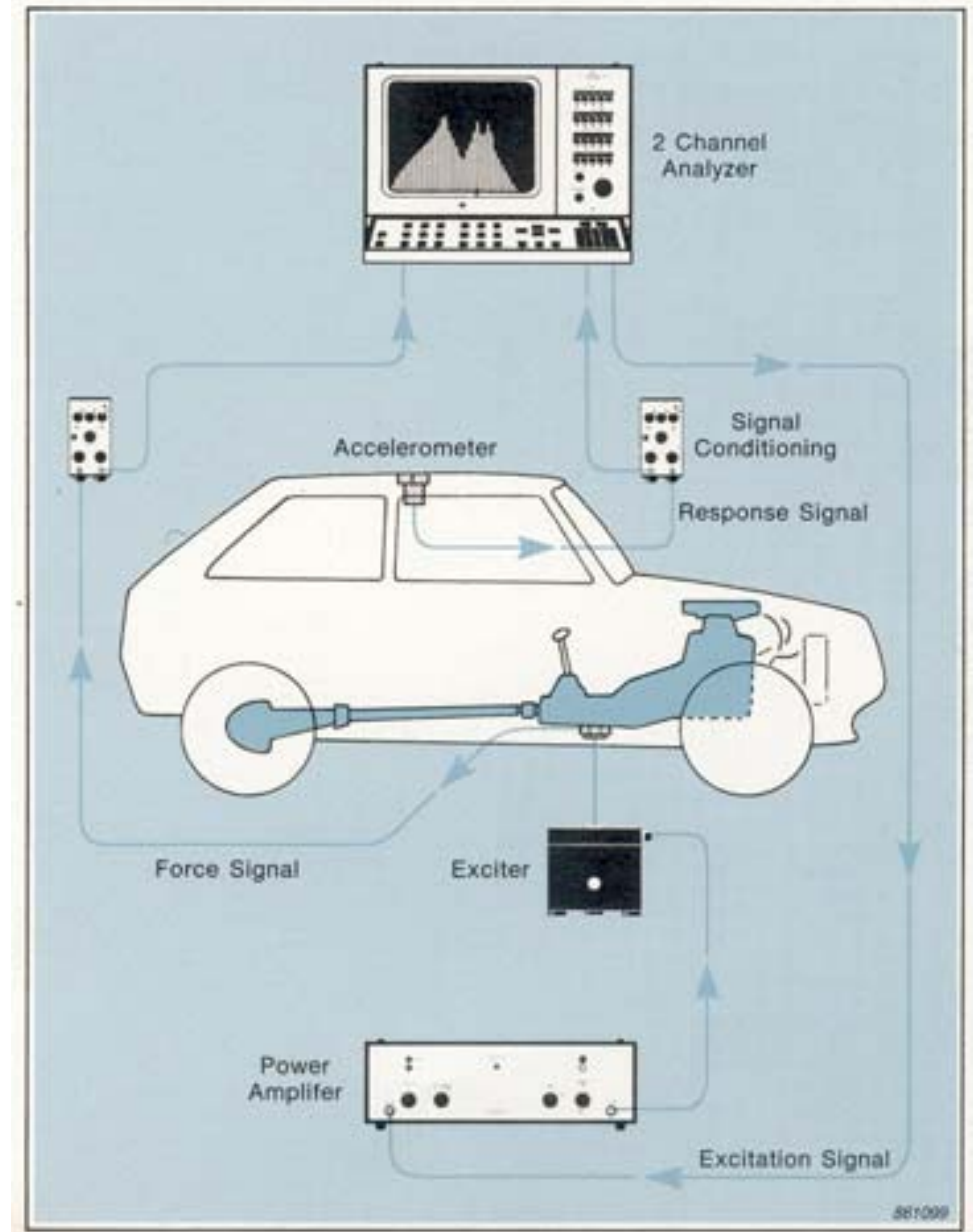

Mobility Measurements - Definitions

The basis for one specific class of experimental modal analysis is the measurement of a set of Frequency Response Functions (FRFs).

Motion can be described in terms of displacement, velocity or acceleration. The corresponding Frequency Response Functions are *compliance*, *mobility* and *accelerance*. In a general sense the term "mobility measurement" is used to describe any form of FRF.

For *modelling*, the FRF most commonly used is compliance. The FRF generally used for *measurements* is accelerance, since the most convenient motion transducer is the accelerometer.

Compliance, mobility and accelerance are algebraically related, the measurement of any one of them can be used for calculation of the others.

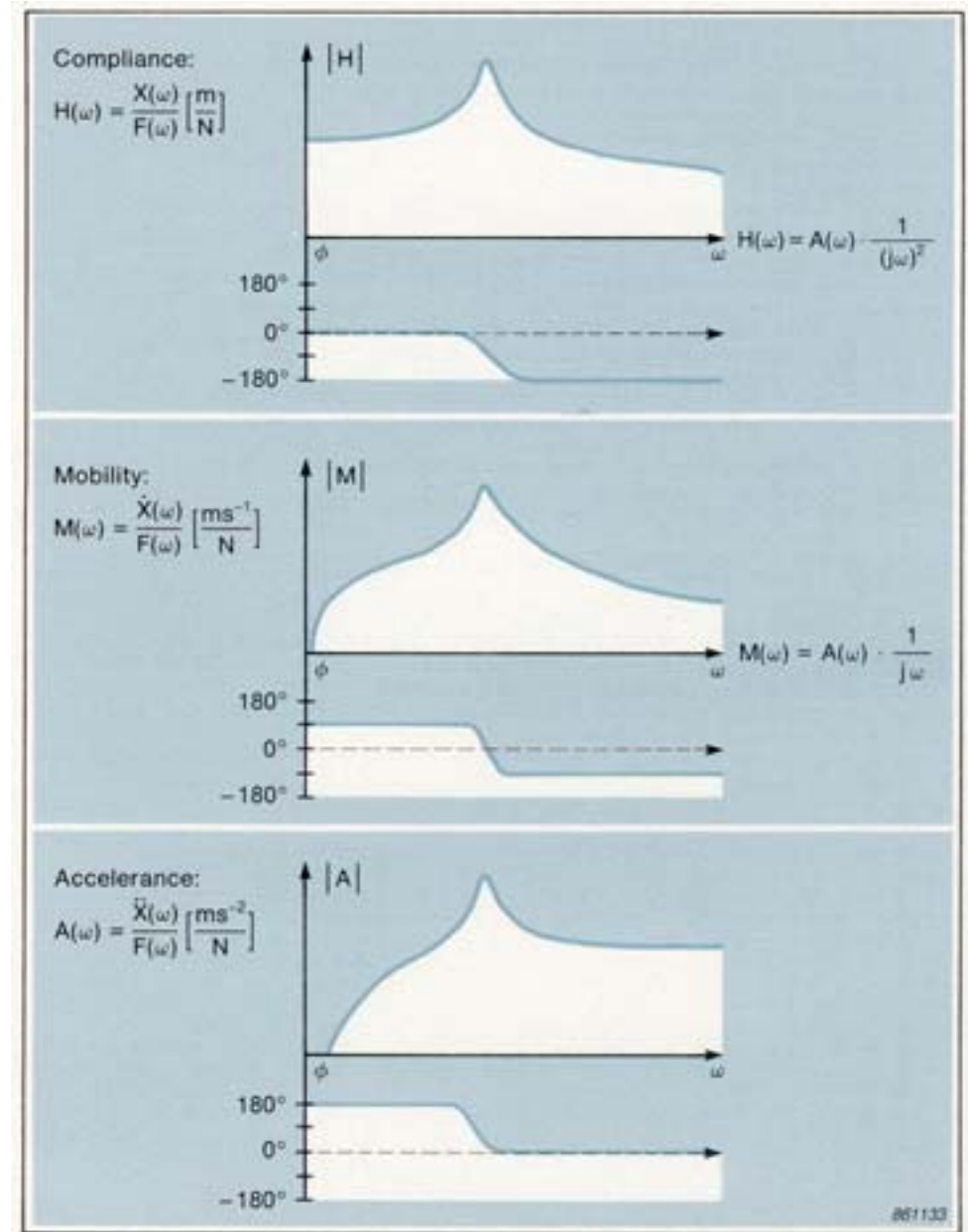

Estimation of the FRF

Ideally a mobility measurement should simply involve exciting the structure with a measurable force, measuring the response, and then calculating the ratio between the force and response spectra. In practice however, we are faced with a number of problems:

- Mechanical noise in the structure, including non-linear behaviour
- Electrical noise in the instrumentation
- Limited analysis resolution

To minimize these problems we have to apply some statistical methods to decide how to estimate an FRF from our measurements. Estimation from data containing random noise generally involves some form of averaging.

What techniques can we use for averaging the output/input ratio?

- Can we take the sum of n response spectra and divide by the sum of n force spectra?

$$H(\omega) = \frac{\sum X(\omega)}{\sum F(\omega)}$$

No we cannot. Spectra are complex quantities, and the sums will converge to zero since the phase between the individual spectra is random.

- Can we take the sum of n ratios between response and force divided by n?

$$H(\omega) = \frac{1}{n} \sum \frac{X(\omega)}{F(\omega)}$$

No we cannot. If the force has a random character, it may be zero at any frequency in individual spectra. The corresponding frequency lines of the FRF will then be undefined.

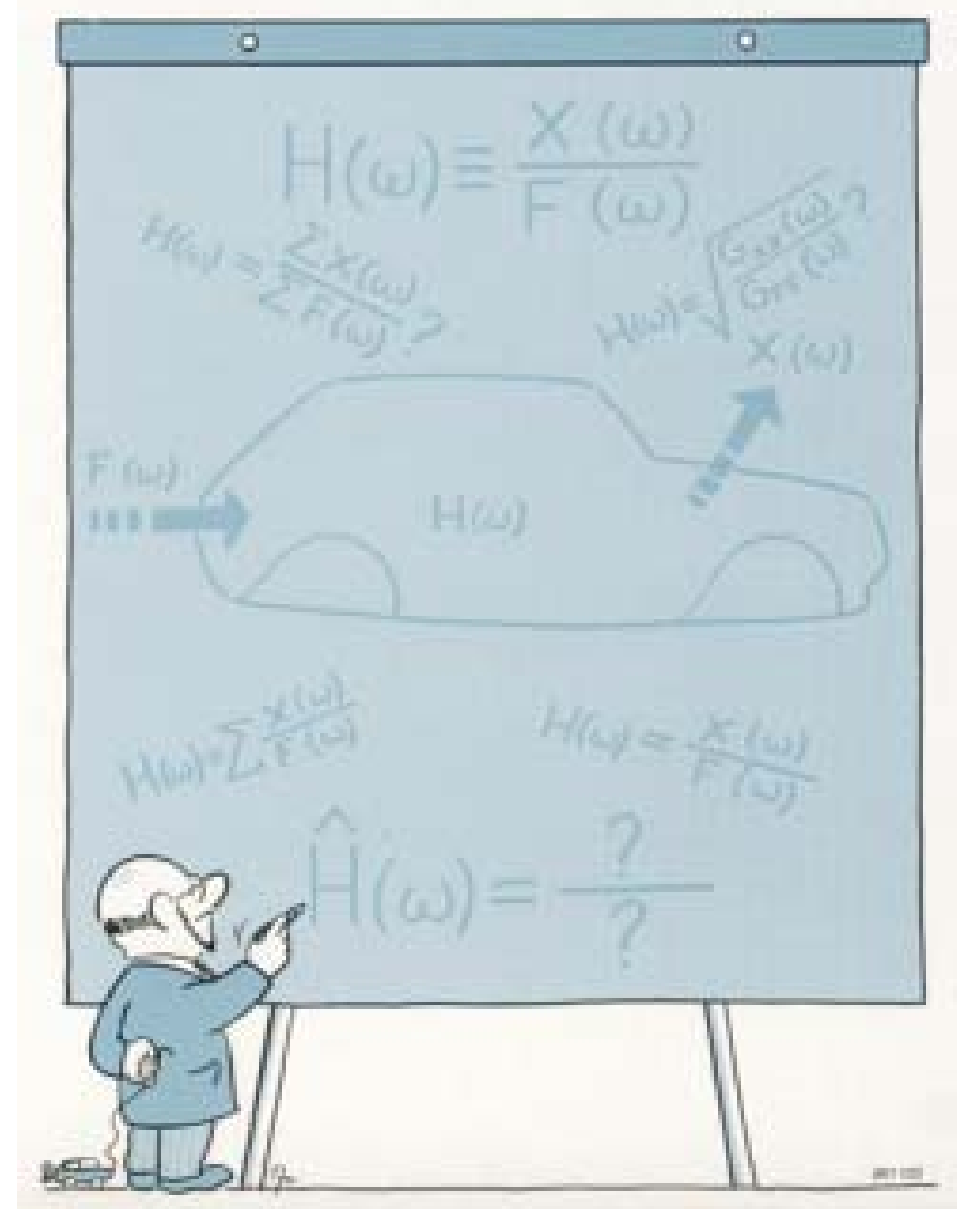

An analysis of a practical measurement may lead us to an useful estimator.

• **Noise in the output measurement**

For the measurement, the test structure is suspended by some means. The force signal is measured by a force transducer directly connected at the point where the force is applied. Apart from some very low level electrical noise in the instrumentation the true excitation can be measured.

Other dynamic processes - machines, wind, footsteps etc. - may, together with sound and internal dynamic processes, result in mechanical noise producing vibration in the test object. The response signal not only contains the response due to the measured excitation, but also the response due to the ambient random excitation. We can therefore characterize this typical measurement as having *noise in the measured output signal*.

Using the principle of least squares, to minimize the effect of noise at the output, we find that the best FRF estimator is

$$\hat{H} = \frac{\sum F^* \cdot X}{\sum F^* \cdot F}$$

This estimator we will call H_1 . It can be seen that it is equal to the Cross Spectrum, between the response and force, divided by the Autospectrum of the force

$$H_1(\omega) \equiv \frac{G_{FX}(\omega)}{G_{FF}(\omega)}$$

The terms Autospectrum and Cross Spectrum are described in the section on the dual-channel analyzer.

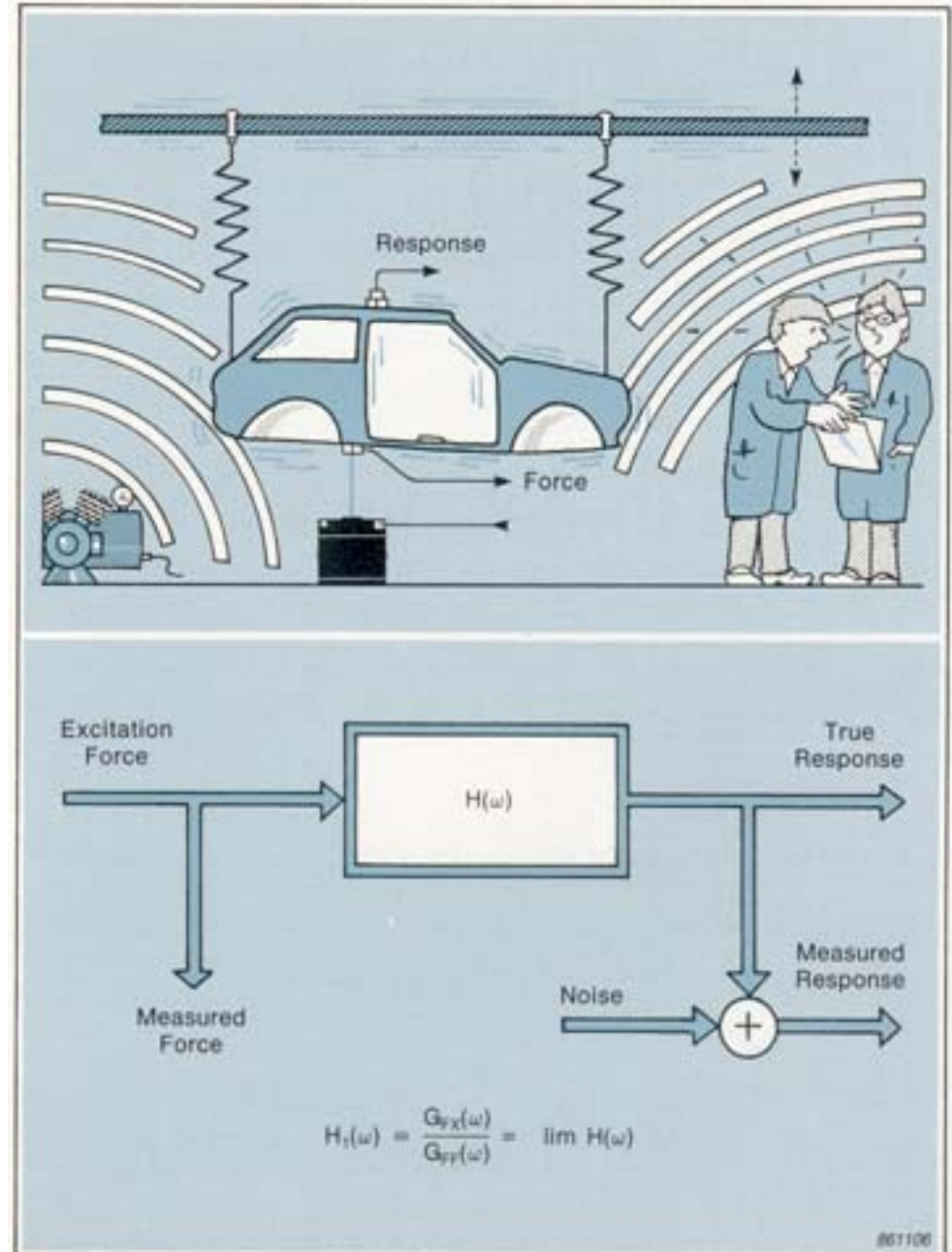

An important point about H_1 is that random noise in the output is removed during the averaging process of the Cross Spectrum. As the number of averages is increased, H_1 converges to the true H .

• **Noise in the input measurement**

In practical measurements on a structure, another noise source may appear when a vibration exciter is used. At its natural frequencies the structure becomes very compliant, which results in high vibration amplitudes. The exciter may then use all the available energy to accelerate its own mechanical components, leaving no force with which to drive the structure. The signal-level of the force may then drop towards the normal noise-level in the instrumentation, in contrast to the response which is at a maximum and likely to drown any noise.

This situation can be characterized as having *noise at the input*. The estimator which minimizes this noise effect is

$$H_2(\omega) \equiv \frac{G_{XX}(\omega)}{G_{XF}(\omega)}$$

By using H_2 , the input noise is removed from the Cross Spectrum during the averaging process. As the number of averages is increased, H_2 converges to the true H .

When noise is present at both output and input, H_1 and H_2 generally form the confidence interval for the true H .

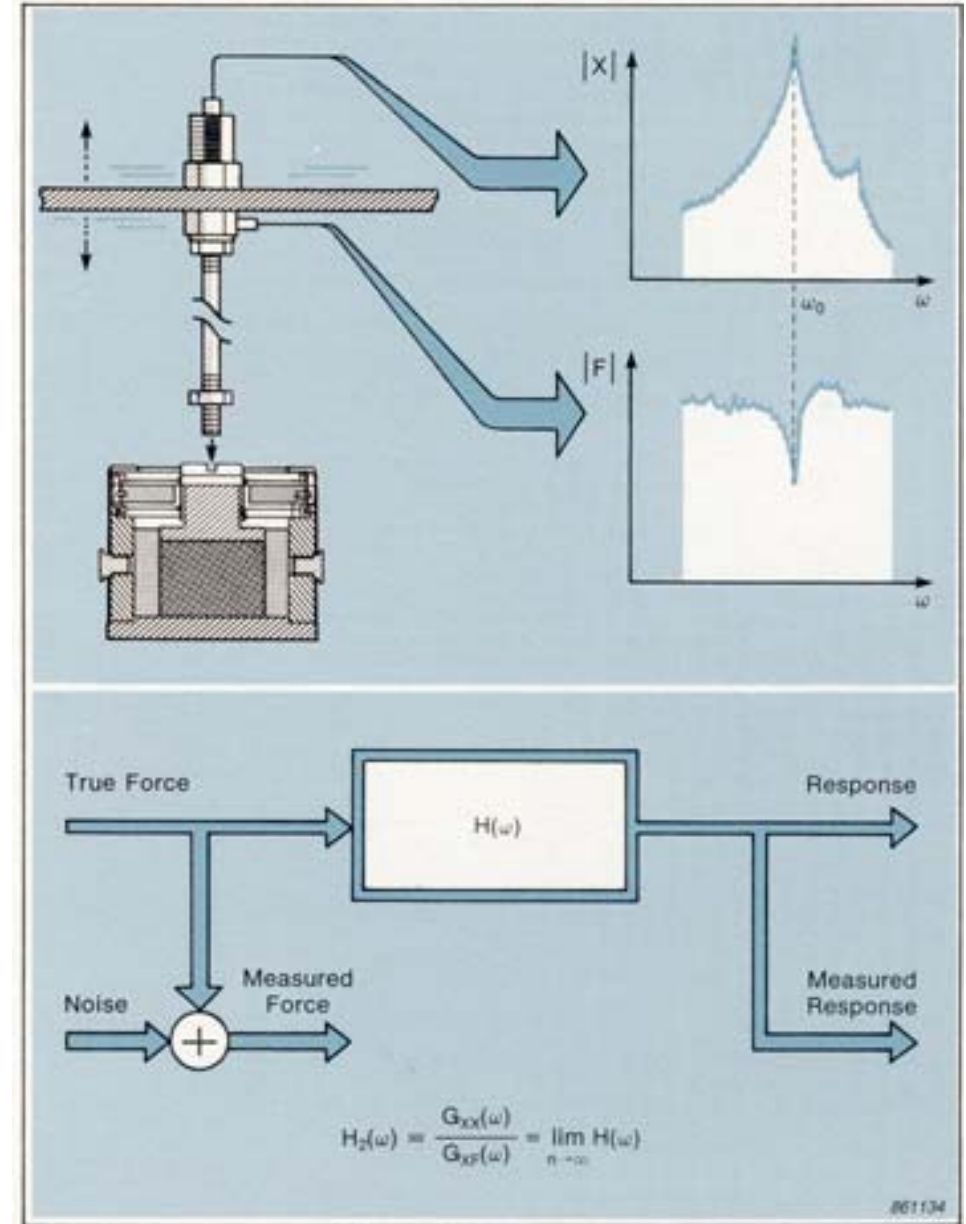

• **The Coherence Function**

The Coherence Function provides us with a means of assessing the degree of linearity between the input and output signals. The Cross Spectrum inequality

$$|Q_{XF}(\omega)|^2 \leq G_{XX}(\omega) \cdot G_{FF}(\omega)$$

states that if any of the Autospectra contains non-coherent noise, then the magnitude of the Cross Spectrum squared is smaller than the product of the Autospectra. This is because non-coherent noise contributions are averaged out of the Cross Spectrum. This relationship gives rise to the definition of the *Coherence Function*

$$\gamma(\omega)^2 \equiv \frac{|G_{FX}(\omega)|^2}{G_{XX}(\omega) \cdot G_{FF}(\omega)}$$

where

$$0 \leq \gamma(\omega)^2 \leq 1$$

The bounds for the Coherence Function are 1, for no noise in the measurements, and 0 for pure noise in the measurements. The interpretation of the Coherence Function is that for each frequency ω it shows the degree of *linear relationship* between the measured input and output signals. The Coherence Function is analogous to the squared correlation coefficient used in statistics.

When making mobility measurements, we will use this powerful property of the Coherence Function to detect a number of possible errors.

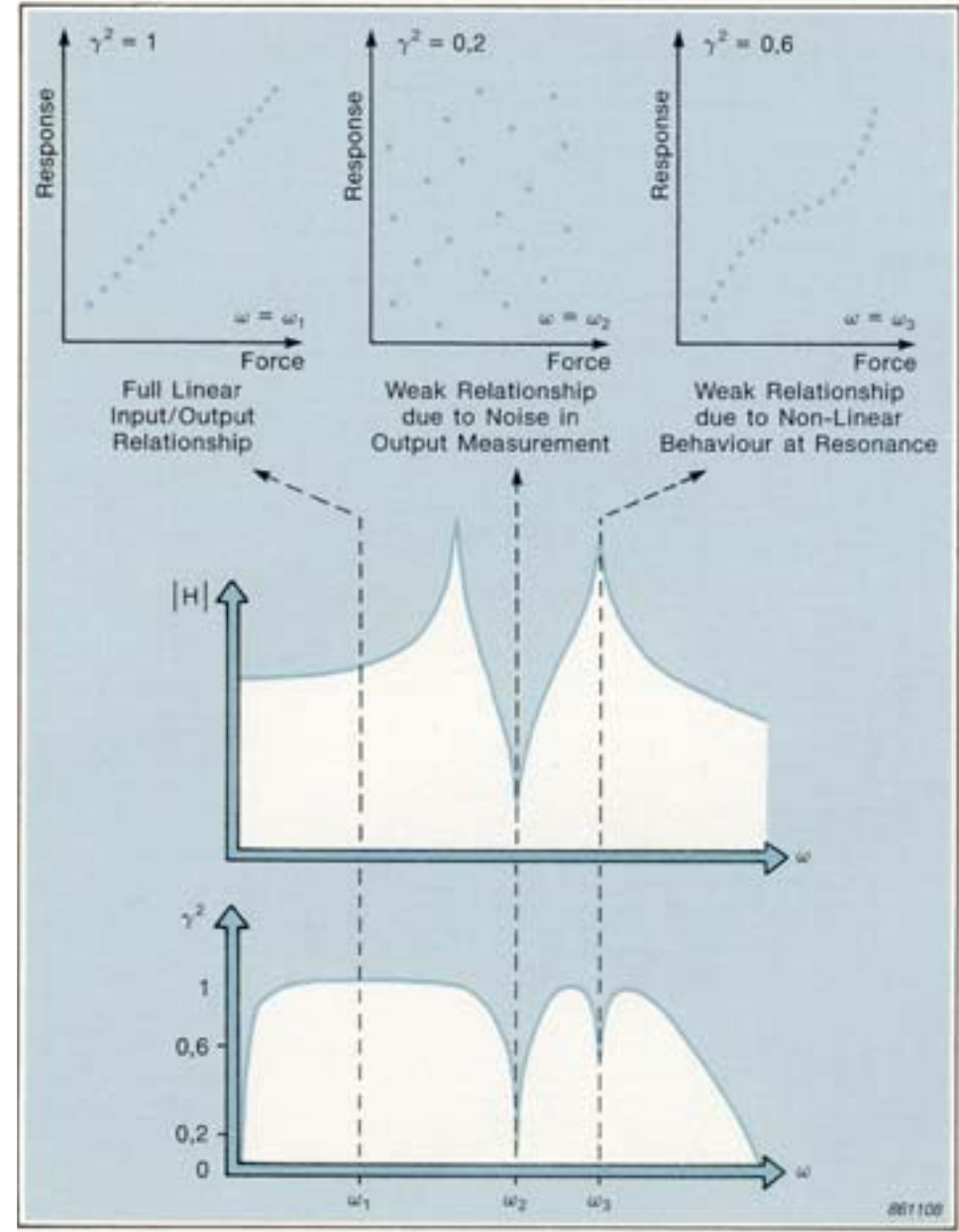

The Dual-channel FFT Analyzer

A dual-channel FFT analyzer can be used to measure H_1 and H_2 . The analyzer can be treated as a "black-box" by the user, who simply needs to provide the analog excitation and response signals, and then press the "FRF button". Let us however, briefly review of the principles of spectrum analysis and discuss a few definitions.

- The analog input signals are filtered, sampled, and digitized to give a series of digital sequences or *records*. Over a finite time these records represent the *time history* of the signals. The sampling rate and the record lengths determine the frequency range, and the resolution, of the analysis.
- Each record from a continuous sequence may be multiplied (weighted) by a *window* function. This tapers the data at both the beginning and end of each record to make the data more suitable for block analysis.
- The weighted sequence is transformed to the frequency domain as a complex spectrum, by the use of a *Discrete Fourier Transformation*. This process is reversible - an inverse transformation will give the original time sequence. To estimate the spectral density of a signal, some averaging technique has to be used to remove noise and improve statistical confidence.

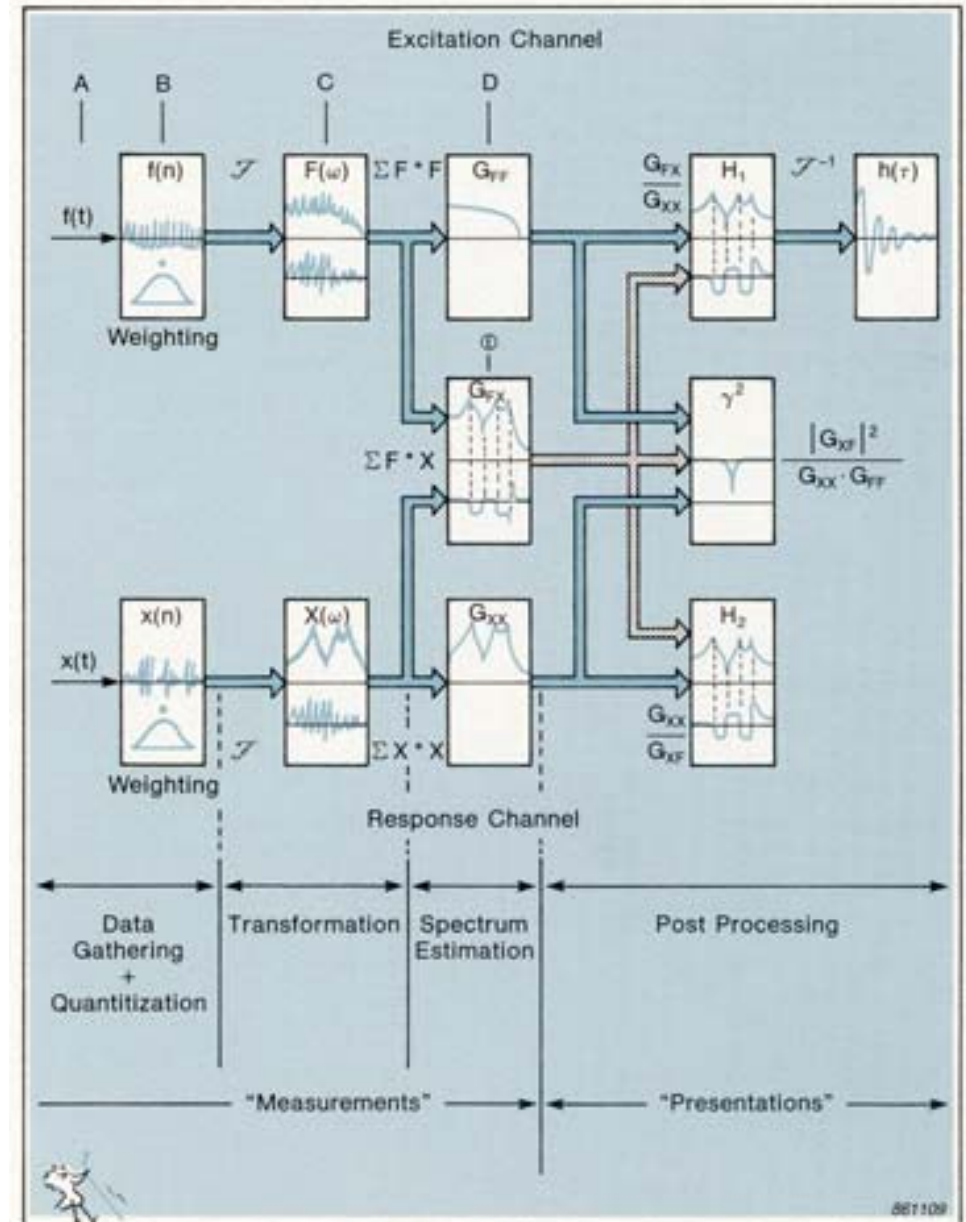

D) An Autospectrum is calculated by multiplying a spectrum by its complex conjugate (opposite phase sign), and by averaging a number of independent products.

E) When the complex conjugate of one spectrum is multiplied by a different spectrum we obtain the Cross Spectrum. The Cross Spectrum is complex, showing the phase shift between the output and input, and a magnitude representing the coherent product of power in the input and output.

The Autospectra of the force and the response, together with the Cross Spectrum between the force and response are exactly the quantities we need for our FRF and Coherence estimates.

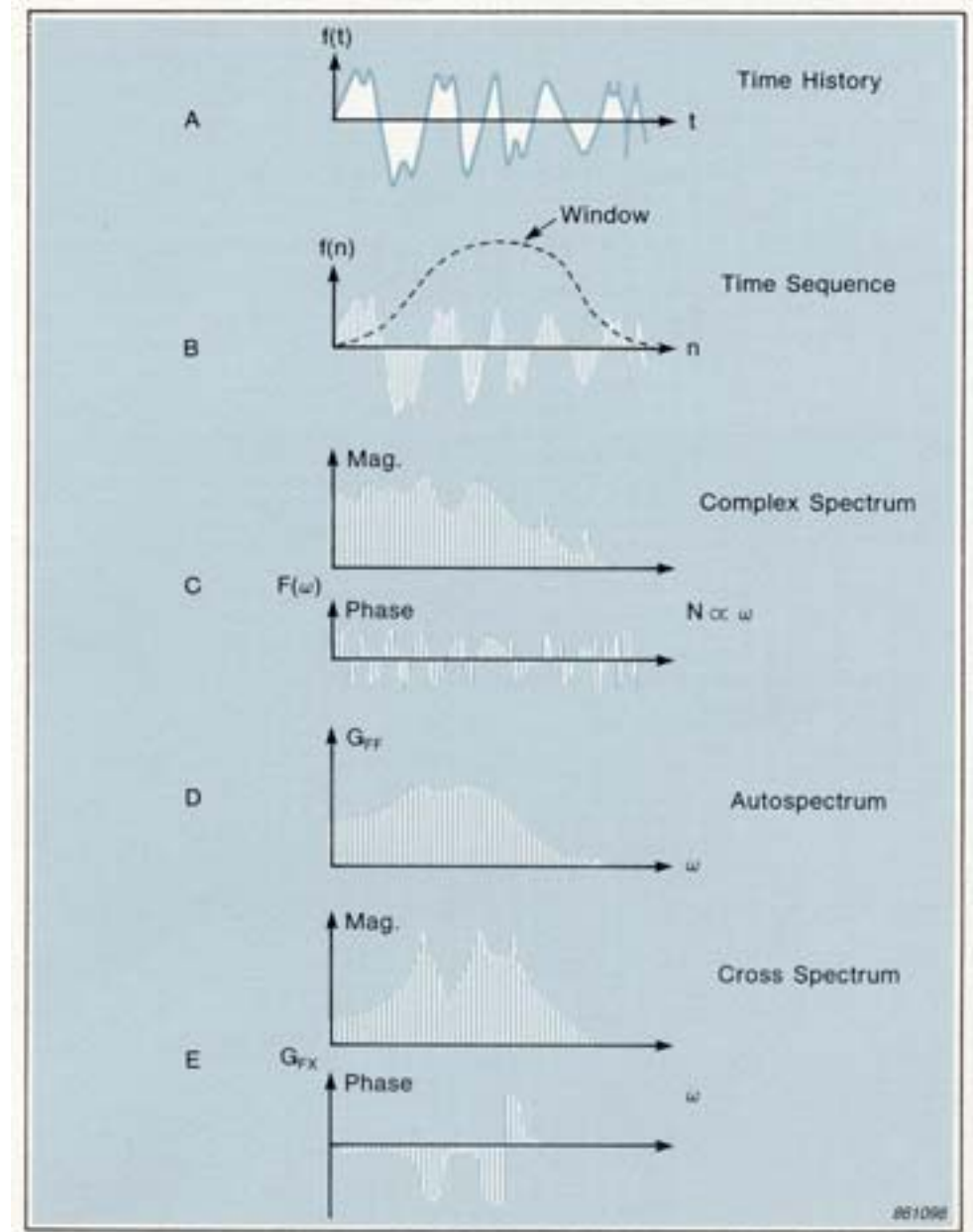

Errors

When making mobility measurements we need to be familiar with a number of possible errors, so that we can recognise them and minimize their effect. These errors can be divided into two classes.

The first class are *random errors*. They are observed as random scatter in the data, caused by noise.

The second class are *bias errors*. They are systematic errors which appear with the same magnitude and phase at each observation.

Estimators contaminated by random errors can be improved by averaging. Bias errors can only be minimized by using a different estimator.

The table shows the classification of typical error sources, which estimators can be used to minimize particular errors, and when the Coherence Function can (+), or cannot (0), indicate the error.

Error	Estimator		
	H ₁	H ₂	γ^2
Noise at the output (response to unmeasured excitation forces)	R	B	+
Noise at the input	B	R	+
Random Excitation Non-linear System	B/R	B/R	+
Deterministic Excitation	B	B	0
Scatter of impact point/direction	R	R	+
Random Excitation Leakage	B	(B)	+
Deterministic (impact)	B	B	0
B = Bias error (systematic) R = Random error (minimized by averaging)			

• **The leakage error**

Due to the nature of the Discrete Fourier Transform, a bias error can occur when the response has very narrow resonances, compared to the frequency resolution being used.

Narrow resonances will ring for a long time, which in this context means that a narrow frequency event corresponds to a long time period. As we are only gathering data over a limited time record, it is possible for the response signal to be truncated.

Truncation in time results in leakage in frequency. Leakage shows up by the measured peaks being too broad and too low. It can be regarded as the result of working with too little frequency resolution for the analysis.

Although leakage is a bias error, practice shows that the H_2 estimator can reduce the error dramatically. In a typical measurement we generally excite the structure using a flat spectrum, which can be measured without leakage errors. The Cross Spectrum reflects the sharp peaks in the response, and may be distorted by leakage. H_1 is the ratio between a spectrum with leakage and a spectrum without leakage; H_1 therefore includes leakage. H_2 , by contrast, is a ratio between two spectra with sharp resonances, both prone to leakage errors, in the ratio the errors tend to cancel out.

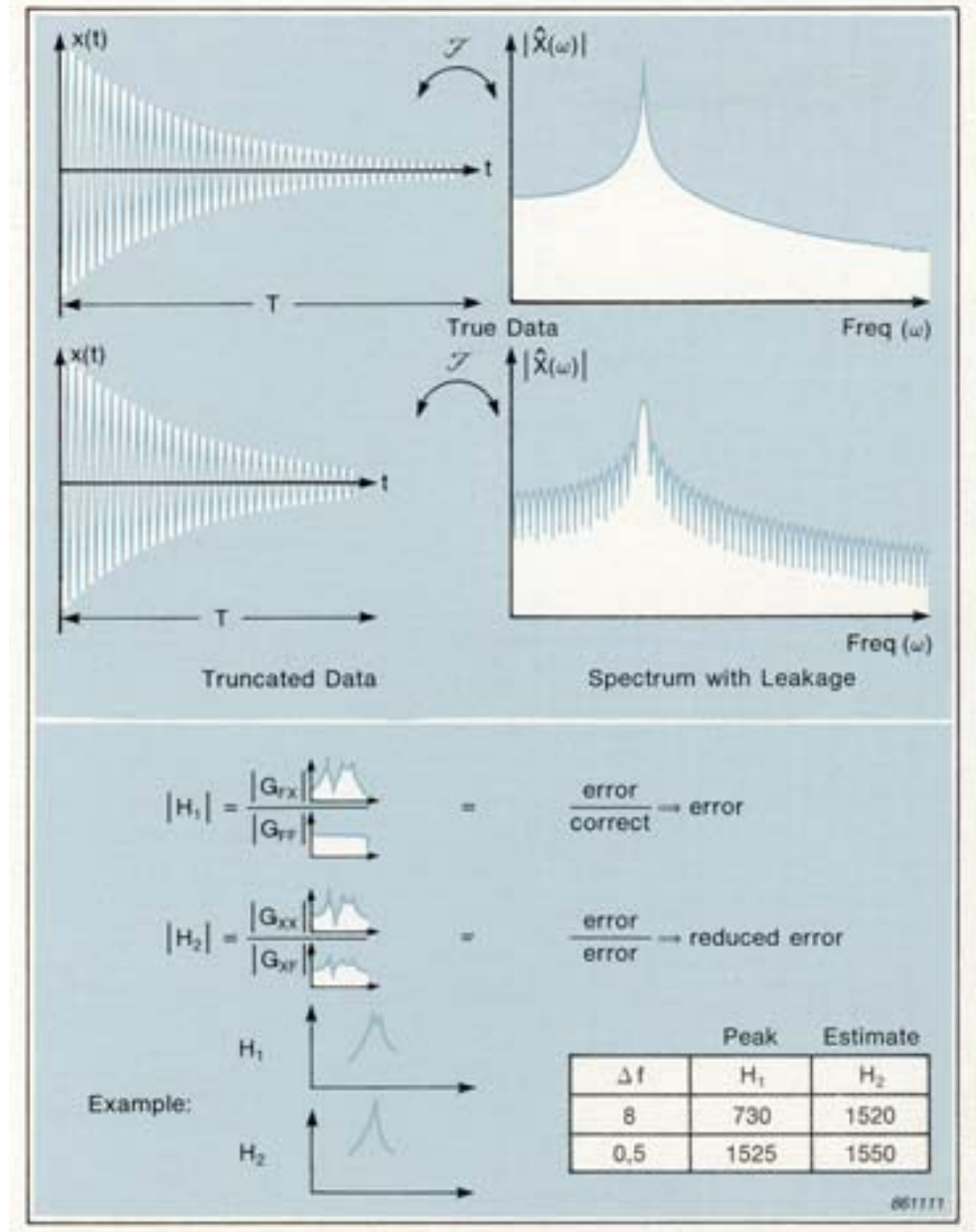

Choice of Optimal FRF Estimator

To conclude our discussion on FRF estimators and measurement errors, we can establish some rules of thumb to help the test engineer.

In any given measurement, it is likely that at some frequencies there will be noise at the input, at other frequencies noise at the output and, at certain frequencies, noise at both input and output.

For systems with high resonances and deep antiresonances, no estimator will cover the entire frequency range without introducing bias errors. The optimal estimator must be chosen on the basis of the FRF itself.

- Random excitation and resonances. H_2 is the best estimator because it cancels noise at the input, and is less sensitive to leakage.
- Antiresonances. H_1 is the best estimator, since the dominant problem is noise at the output.
- Impact excitation and pseudo-random excitation. H_1 and H_2 will generally be equal at the resonances. H_1 is preferred since it is the best estimator at antiresonances.

In general, with random noise in both the input and output, H_1 and H_2 form the confidence limits for the true H

$$H_1 \leq H \leq H_2$$

Note: This inequality is not valid for the non-linear leakage error, or for noise which is coherent in the input and output, such as mains hum.

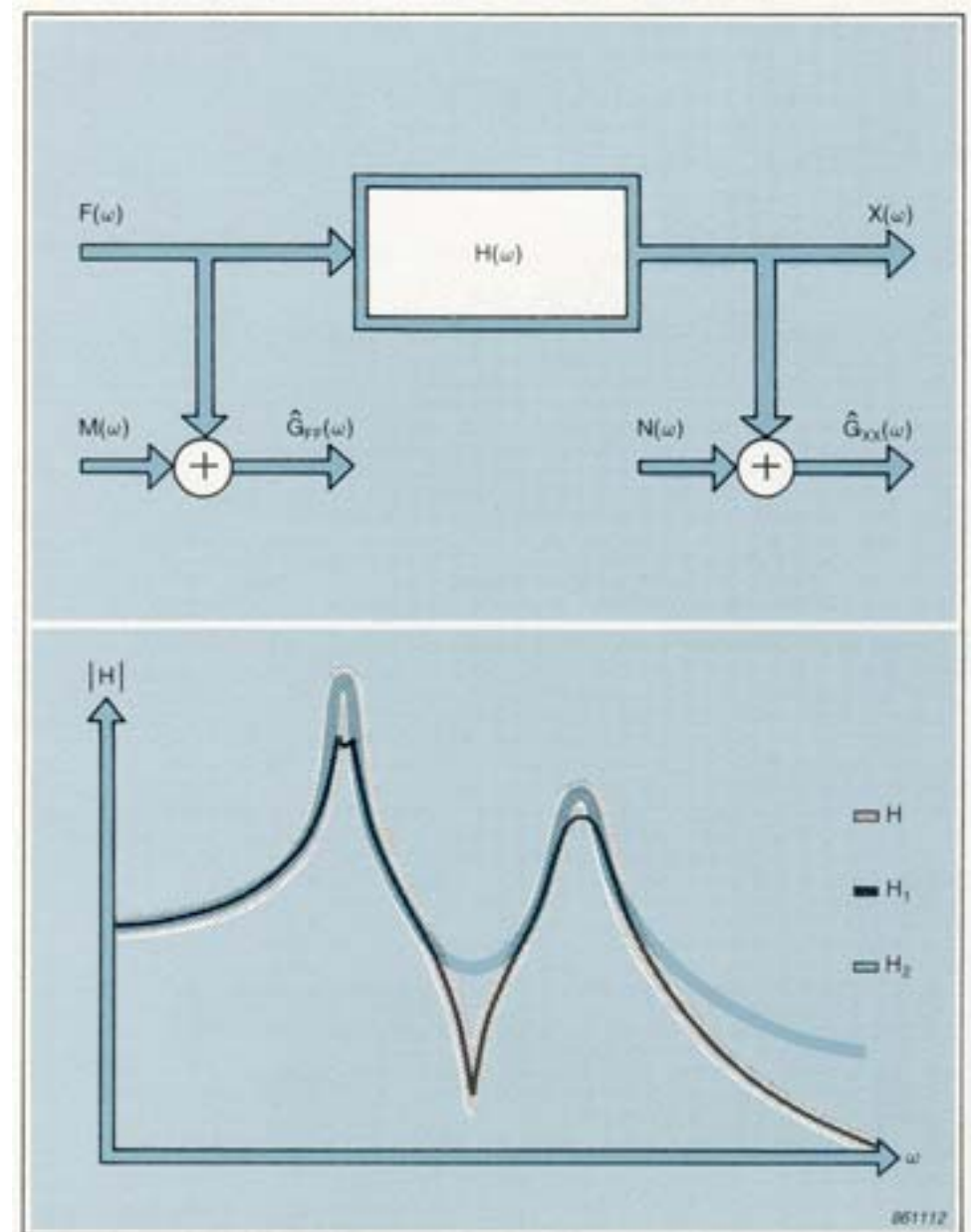

Excitation

For mobility measurements the structure must be excited by a *measurable* dynamic force, but there is no theoretical restriction as to waveform, or to how the excitation is implemented.

• Excitation waveform

In this discussion we will limit ourselves to waveforms which have energy distributed over a wide band of frequencies. These can simultaneously excite the structure over the entire frequency range of interest.

Certain parameters should be considered before choosing the excitation waveform:

- Application
- Spectrum control
- Crest factor
- Linear/non-linear structure
- Speed of test
- Equipment available

If the purpose of the test is only to measure natural frequencies, then the precision required is much less than when the measurements are to form the basis for a mathematical model. The cost of extra precision lies in the time taken for the measurements, and in the cost of the instrumentation.

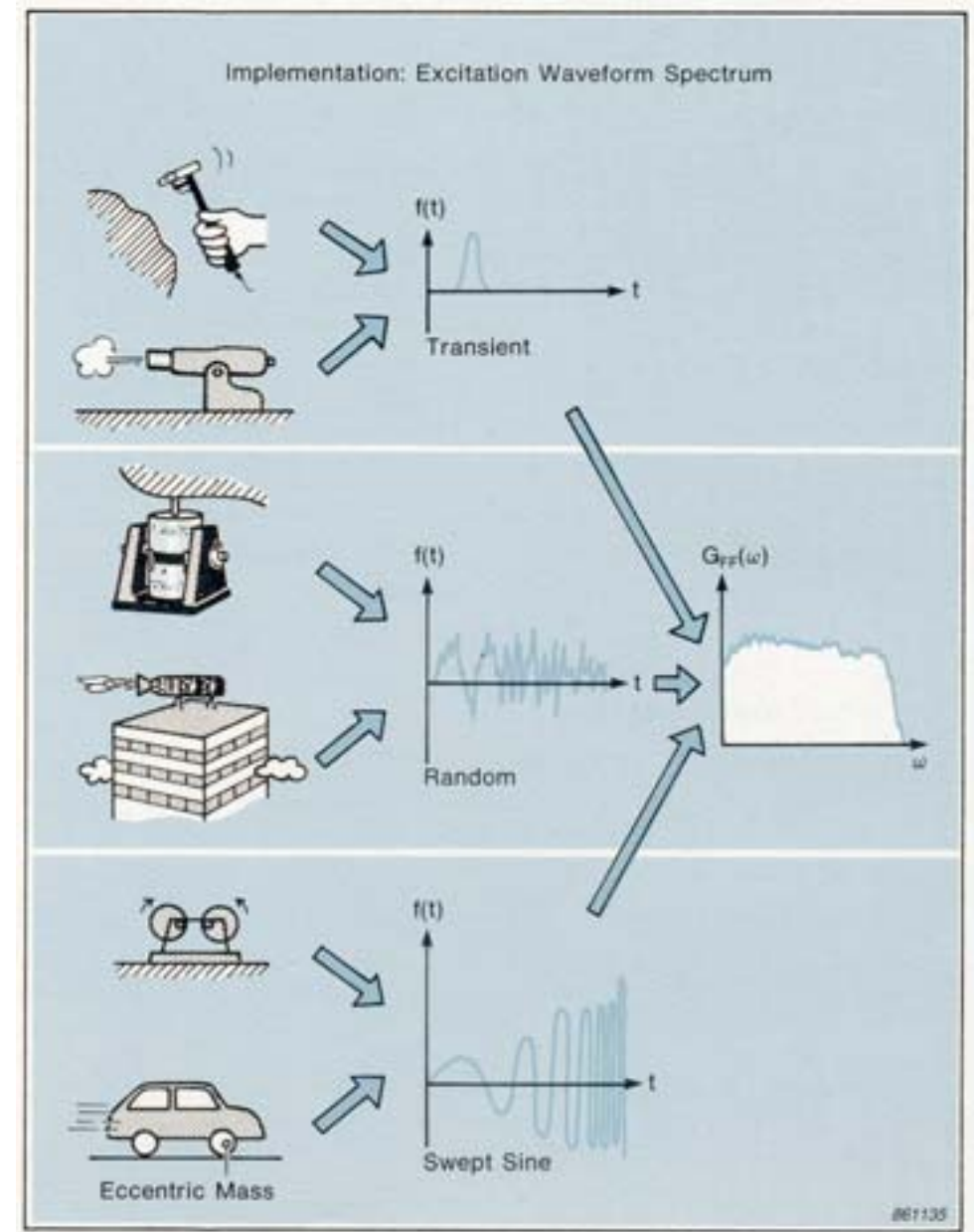

Spectrum control is the capacity to limit the excitation to the frequency range of interest.

The dynamic range of an FRF is often very large, when measured between the highest resonance peak and the deepest antiresonance. Since the excitation waveform is generally chosen to have an ideally flat spectrum, it follows that the response spectrum will have the same large dynamic range as the FRF. If the structure is excited only in the frequency range of interest, the dynamic range of the measurement is minimized. This results in a better signal-to-noise ratio, and cleaner data.

The crest factor describes the "peakiness" of the signal. It is defined as the ratio between the peak and the standard deviation (RMS) in the signal. A high crest factor in the excitation wave-form has two disadvantages:

- The signal-to-noise ratio is decreased, since the instrumentation must make allowances for the peaks, and some of the signal is lost in the existing noise.
- High peak forces may provoke non-linear behaviour in the structure.

An expectation of *non-linear* behaviour in a structure raises the question: "Do we want to describe the non-linear behaviour, or do we want to make a *linear approximation*?"

Modal analysis assumes linear systems and uses linear models. If we deal with a structure exhibiting some non-linear behaviour, we generally attempt to make the best linear approximation. Selecting a waveform that excites the structure over a wide variety of levels randomizes the non-linear behaviour which is then averaged out. To study non-linearities, sinusoidal excitation with maximum amplitude control is generally used.

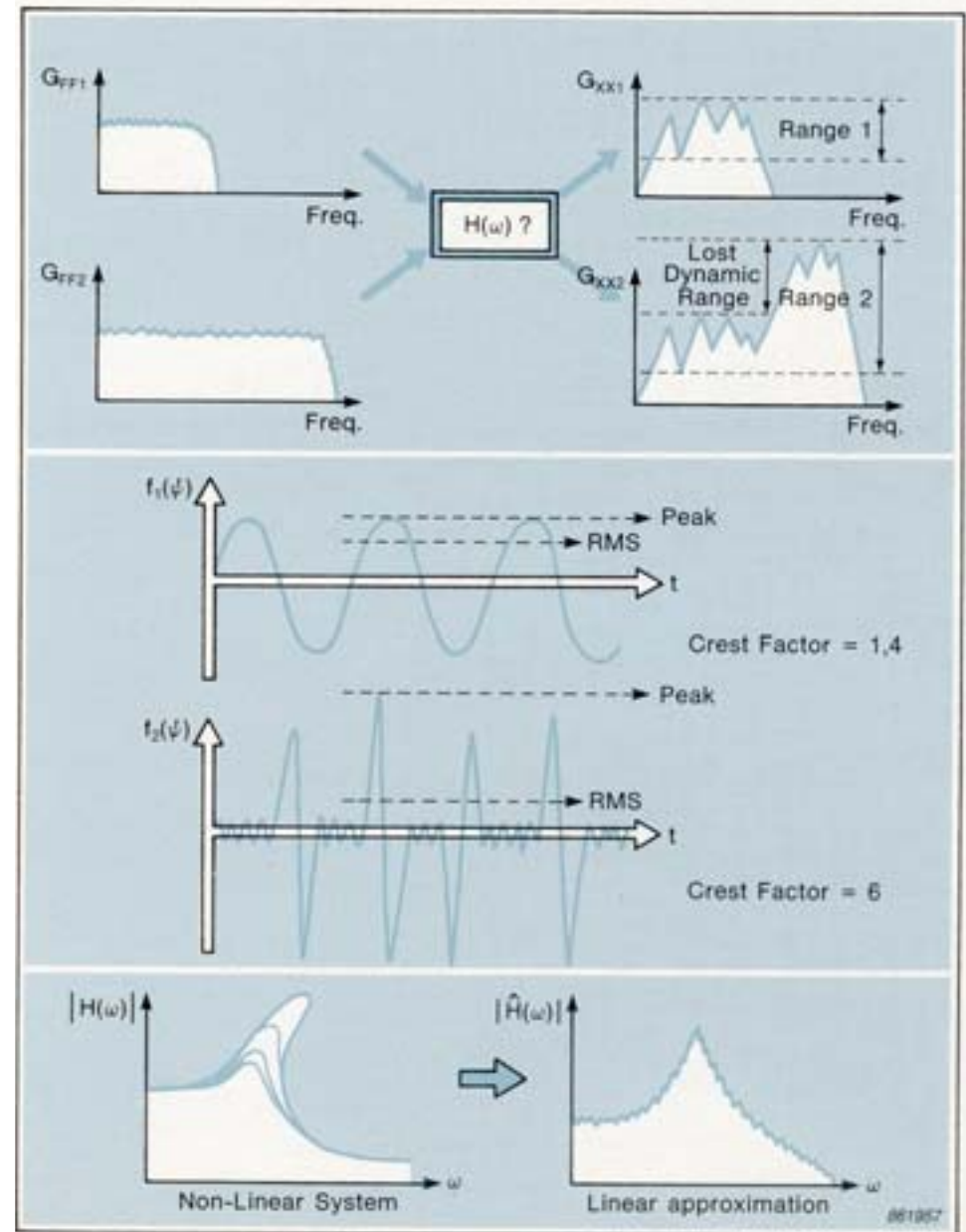

Implementing the Excitation

Excitation forces can be generated by many different kinds of devices. For broadband excitation we will consider two classes, attached and non-attached exciters.

Examples of attached exciters are:

- Electromagnetic shakers
- Electrohydraulic shakers
- Eccentric rotating masses
- More exotic devices such as rockets or guns

Examples of non-attached exciters are:

- Hammers
- Large pendulum impactors
- Suspended cables to produce "snap-back"

Note: Acoustic excitation cannot be used in modal analysis, since control of direction and excitation point is not possible. It can be used however, for checking modal frequencies, and for producing unsealed mode shapes.

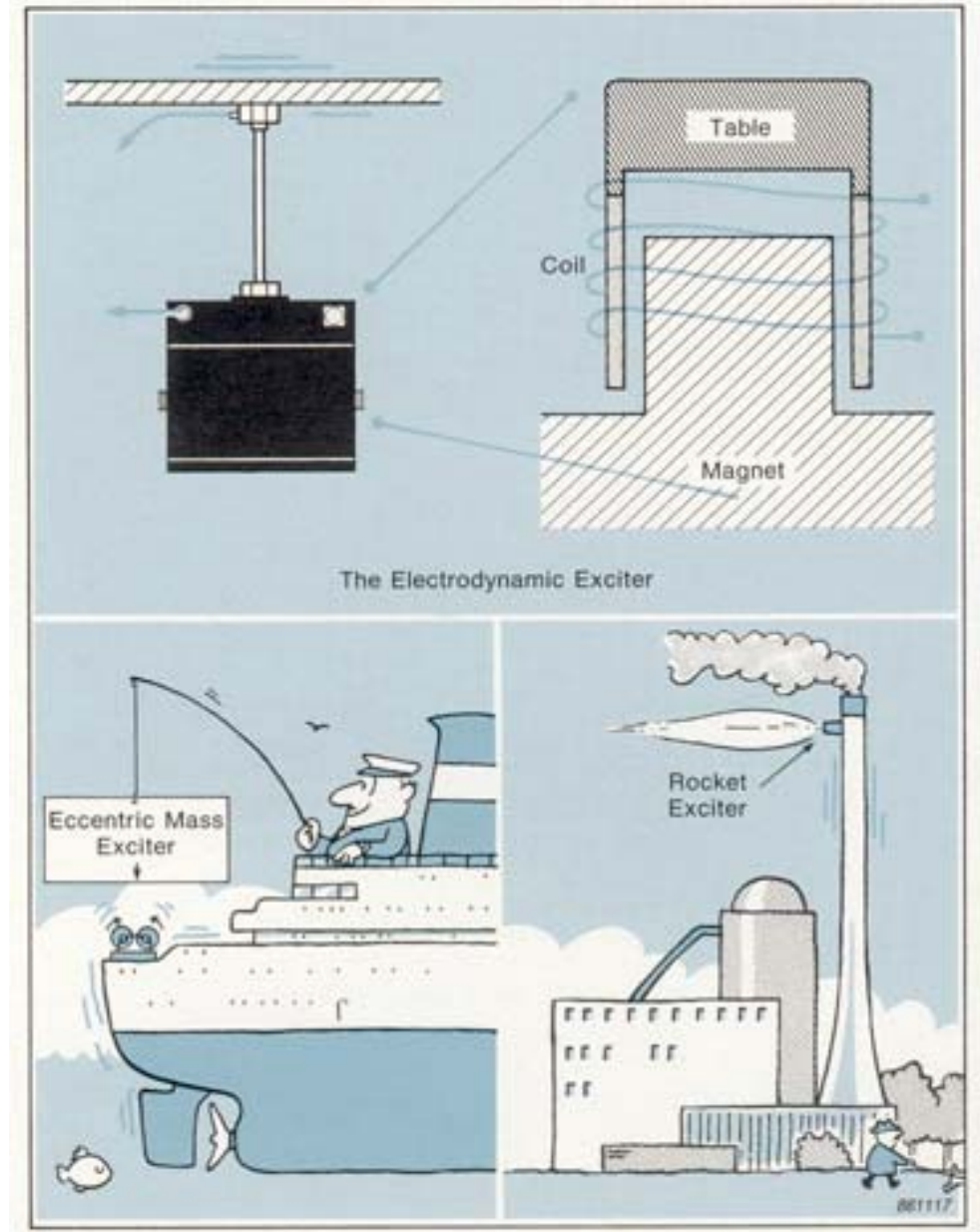

• Force measurement

The excitation force is usually measured by using a *piezoelectric force transducer*, in which a fraction of the force is transmitted through a piezoelectric element.

The advantages of the piezoelectric force transducer are:

- Small size and mass, producing little added mass/damping/stiffness
- Extreme linearity
- Wide dynamic range (120 dB)
- Wide frequency range

The total force generated in an exciter has to drive all the moving parts: the exciter coil/piston, the connection mechanism, and the structure. The exact force exciting the structure can only be measured if the force transducer is mounted directly on, or as close as possible to, the structure.

• Exciter attachment

The exciter must be attached to the structure so that the excitation force acts only at the desired point, and in the desired direction. The structure must be free to vibrate in the other five degrees of freedom at that point, with no rotational or transverse constraints.

A good attachment technique, is to connect the exciter to the force transducer with a slim push rod or "stinger". This type of attachment has high axial stiffness but low transverse and rotational stiffness, giving good directional control of the excitation. An additional benefit is that the stinger acts as a mechanical fuse between the structure and the exciter, protecting both them and the transducer from destructive overloads.

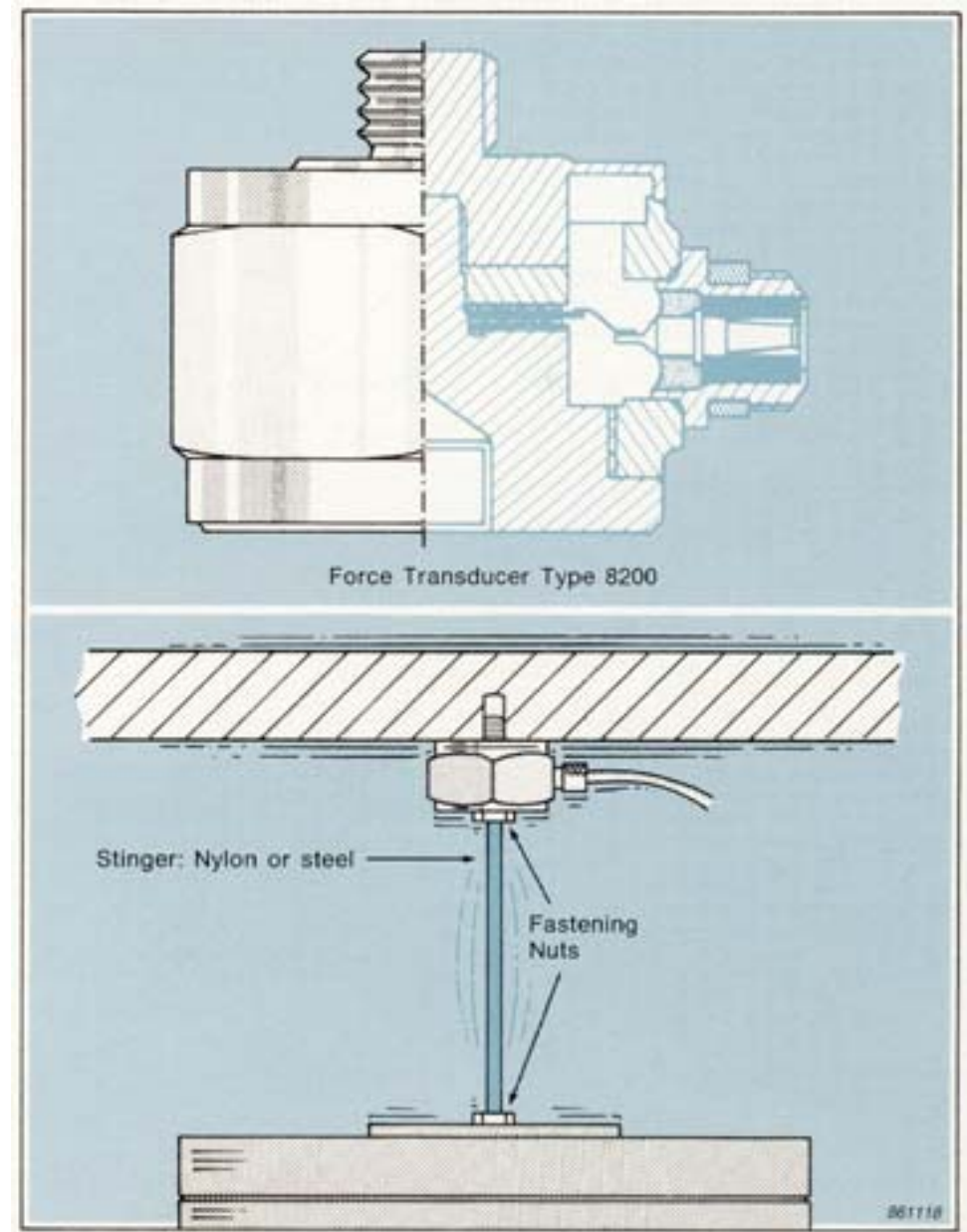

Response Measurements

• Response transducer

For response measurement, any of the motion parameters - displacement, velocity or acceleration - can be measured. The best choice of transducer is the piezoelectric accelerometer, for the following reasons: It offers -

- Good linearity
- Low weight (can be less than 1 gram)
- Broad dynamic range (160 dB)
- Wide frequency range (0,2 Hz to over 10 kHz for better than 5% linearity)
- A strong construction and simple design (some types withstand shocks of over 20,000 g)
- High environmental resistance (Delta Shear® design)
- Low transverse sensitivity
- Simple mounting methods

The velocity or displacement parameters can readily be obtained through electrical integration, either through a conditioning amplifier or using the post-processing facilities of the analyzer.

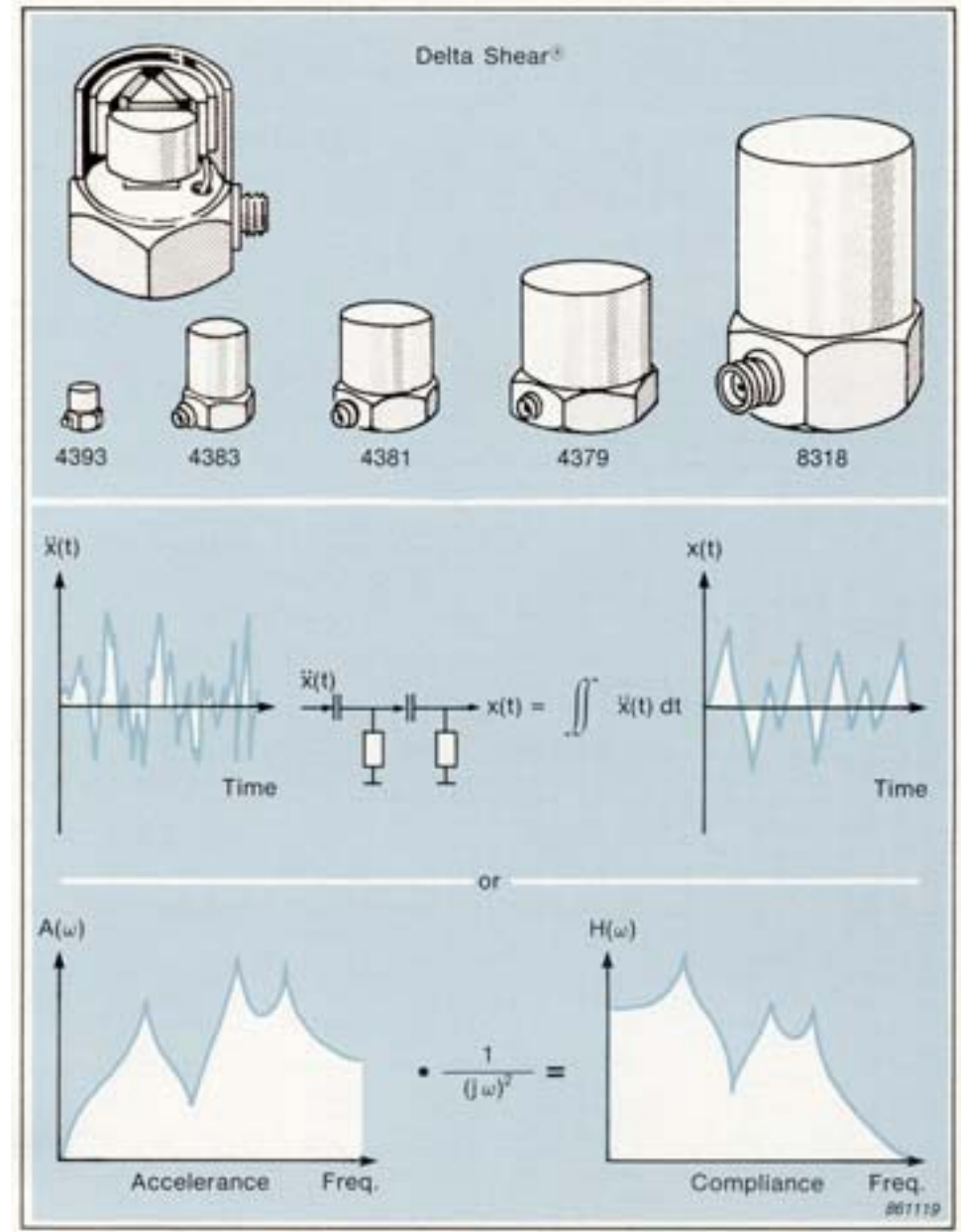

• Transducer mounting

For optimal accelerometer performance, the best mounting technique is to use a threaded steel stud. Tolerances for the mounting surface and recommended mounting torques are normally supplied by accelerometer manufacturers.

This method is not always convenient, possible or beneficial. Other techniques, such as a magnetic mount, or a thin layer of beeswax - applied to the base of the accelerometer before firmly pressing it on to the structure - will also produce good results. These alternative techniques can lower the useful frequency range of the accelerometer, but this rarely gives problems in modal analysis.

In a modal test where it is necessary to obtain scaled mode shapes, a driving-point measurement is needed. A problem that may then arise is how to excite the structure, and measure the driving-point response at the same place, and in the same direction.

The driving-point measurement on large structures can normally be made, without introducing any significant errors, by applying the excitation very close to the transducer. On small structures it is often possible to attach the force and driving-point transducers on opposite sides of the structure at the excitation point. As an alternative, an *impedance head*, an integrated force and response transducer, can be used.

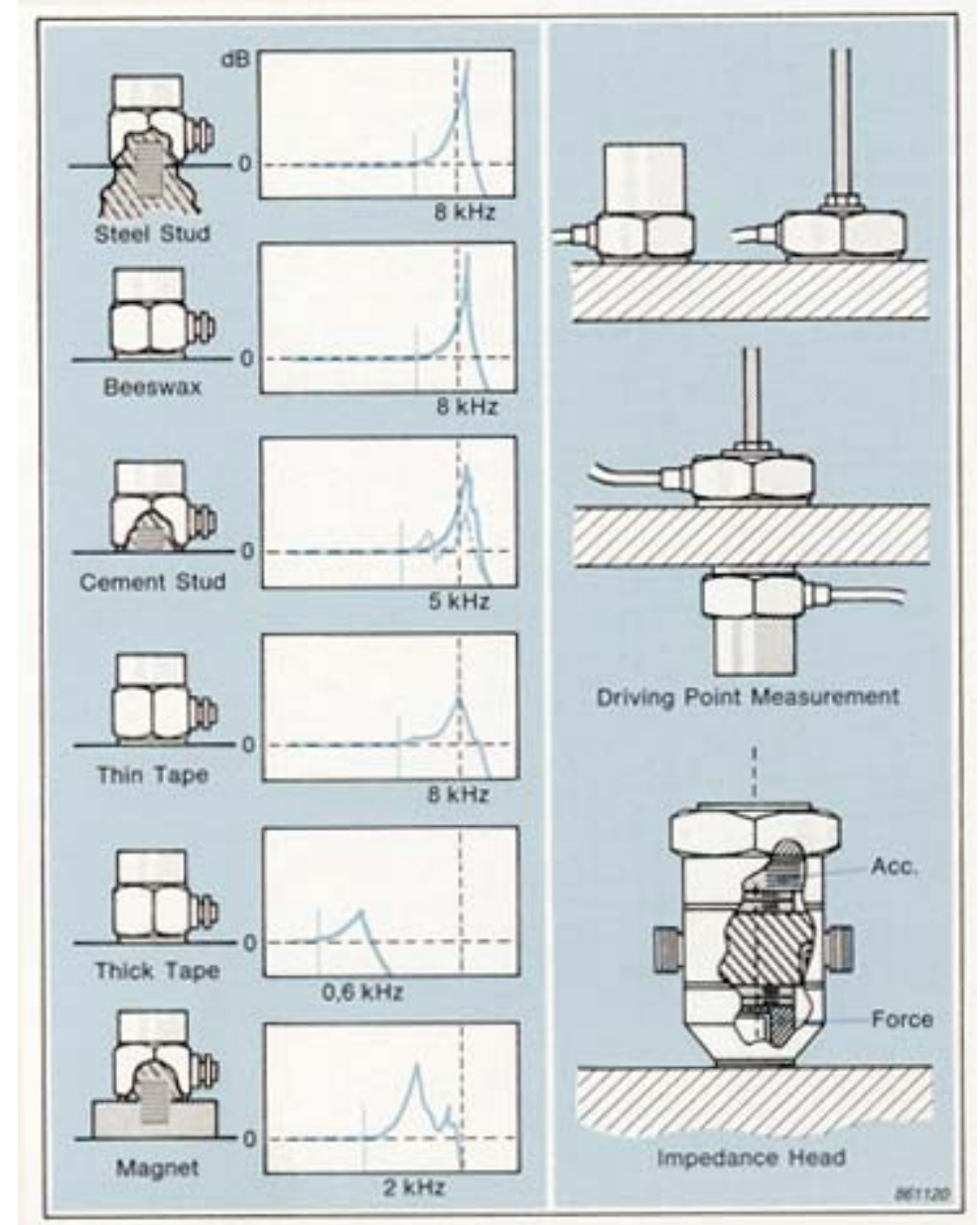

• Transducer loading of the test object

When a response transducer is chosen, the structural loading caused by mounting the transducer must be taken into consideration. Loading the structure may alter the mass, stiffness or damping. The most obvious effect is mass loading, which tends to lower the measured resonance frequencies.

The dynamic mass loading produced by a mounted accelerometer depends on the local dynamic properties of the structure. Dynamic mass, and the resulting frequency shift, is proportional to the square of the local modal displacement (deflection) of the associated mode.

A rule of thumb is to use light transducers on light structures to give minimum loading. Caution must always be exercised, even when testing a heavy structure, since even a low weight accelerometer (20 gram) can significantly change a local panel resonance.

Consideration should also be given to the addition of stiffness and damping due to bending, or friction, at the mounting interface. Once again, small transducers should be used for high frequency work, together with a mounting technique requiring minimum contact area.

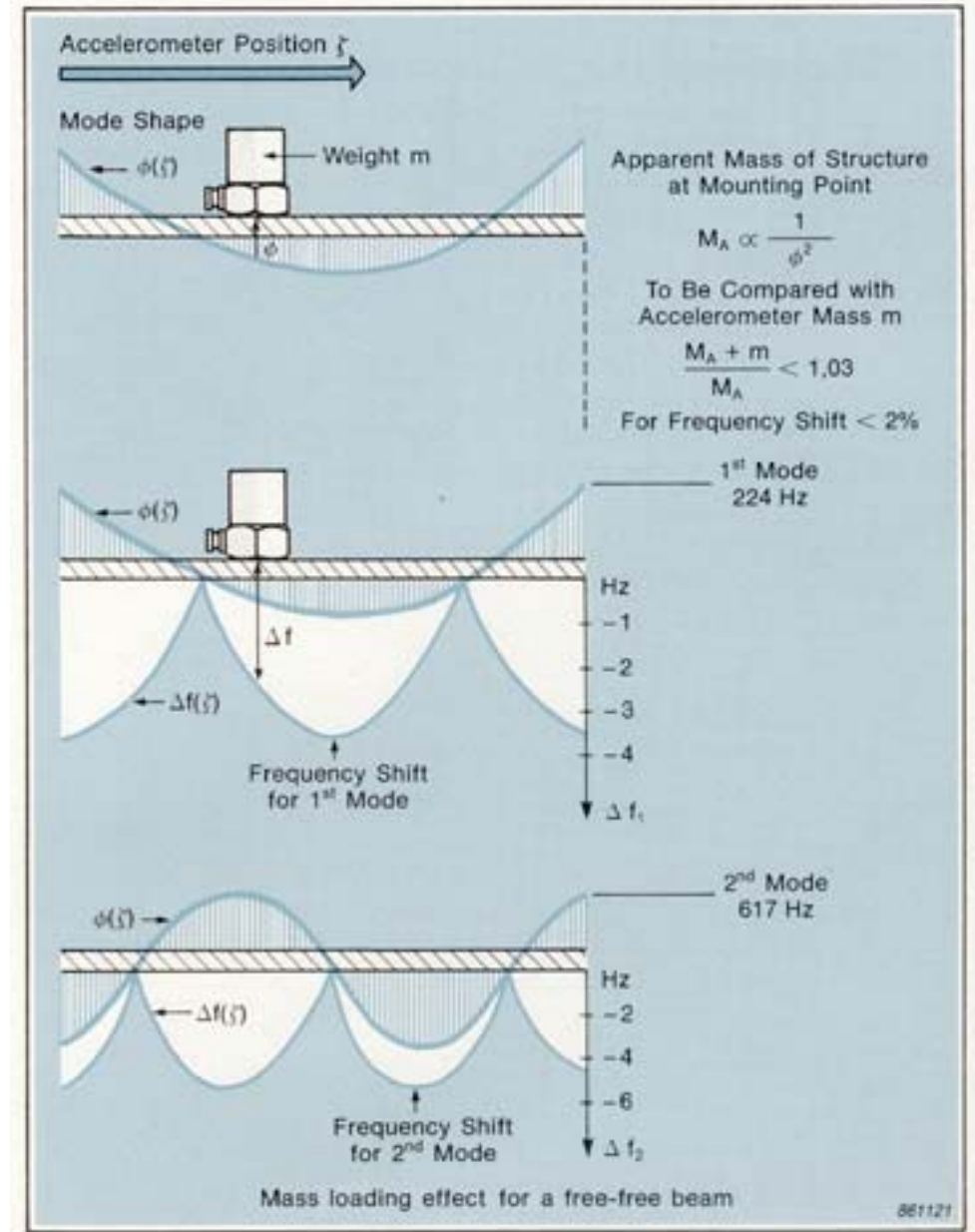

Random Excitation

Here the term random applies to the amplitude of the excitation force which, in statistical terms, has a normal or Gaussian probability distribution.

With this type of excitation, individual time records in the analyzer contain data with random amplitude, and phase, at each frequency. On average however, the spectrum is flat and continuous, containing energy at approximately the same level for all frequencies. Due to the random characteristic of the signal, the structure is excited over a wide force range at each frequency. This randomizes any non-linear effects, and averaging then gives a best linear approximation.

The spectrum frequency distribution is easy to control, so it can be limited to cover the same range as the analysis. The analysis can be made from 0 Hz to an upper limiting frequency ω_u , or from ω_1 to ω_2 for a zoom analysis.

Random excitation waveforms are generated electronically, or digitally synthesized, and fed to a power amplifier driving an electrodynamic vibration exciter. In modern analyzers the waveform generator is built-in, and synchronized with the analysis.

The excitation is random and continuous in time, but the record length is finite, so leakage errors may occur. These errors can be minimized by using a window function, or weighting, which acts as a soft entry and exit for the data in each record. The best weighting function to use with random data is the *Hanning window*.

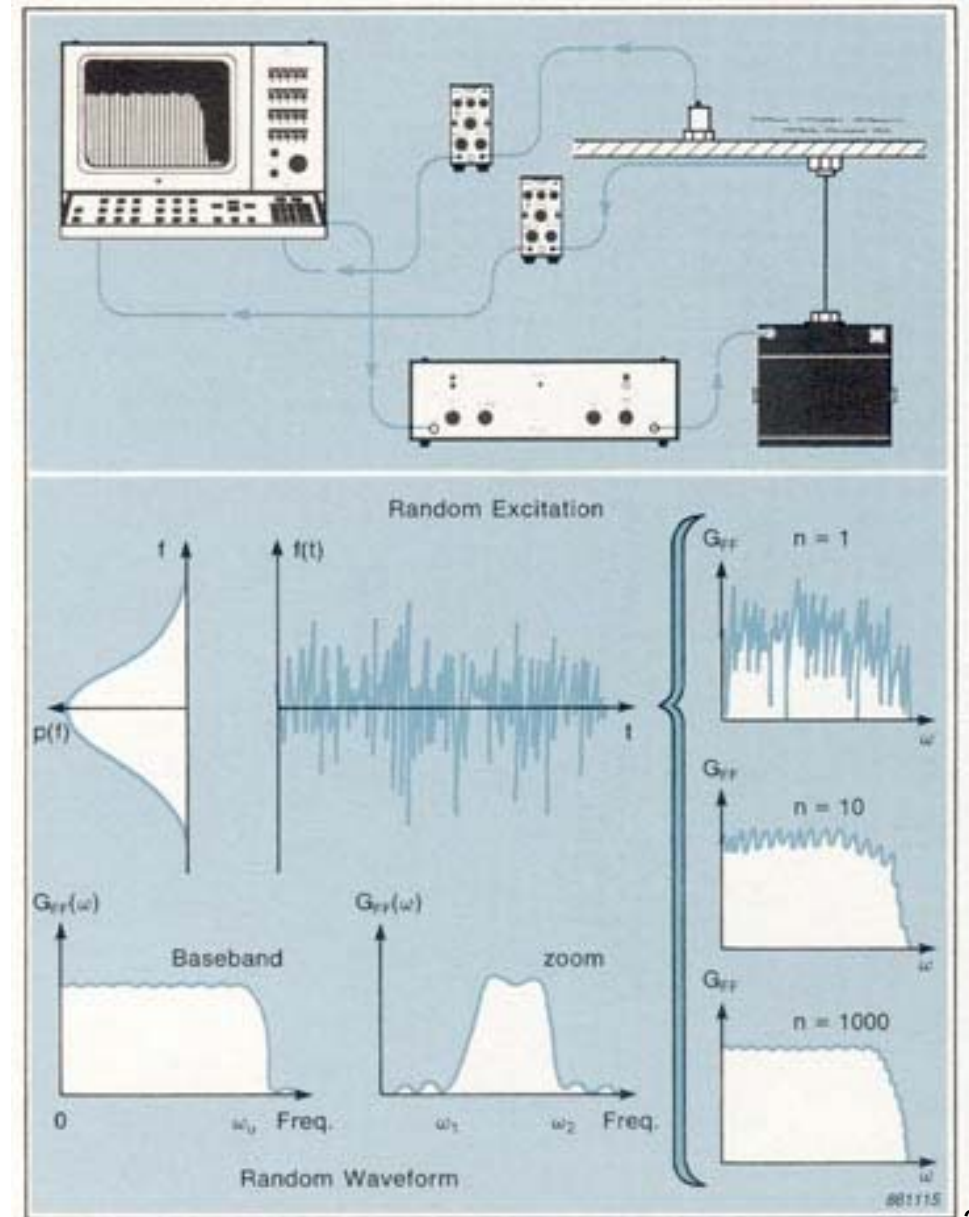

Pseudo-Random Excitation

The pseudo-random waveform is a periodic signal that repeats itself with every record of the analysis. A single time record resembles a random waveform, with a Gaussian-like amplitude distribution. The spectral properties however are very different. Because the signal repeats itself with each record, or is periodic with a period equal to the record length, something dramatic happens to its spectrum:

- The spectrum becomes discrete, only containing energy at the frequencies sampled in the analysis. We can consider the signal to be a collection of sinusoids with the same amplitudes but random phases.
- Every individual spectrum when measured has the same amplitude and phase for each frequency. This indicates that averaging will have little effect, except to remove random noise. As the structure is excited at the same force amplitude all the time, no linear approximation can be obtained through averaging.
- The periodic nature of the signal removes the leakage error, and rectangular weighting must be used.

Operation and control are similar to those for the random waveform; in this case the signal generator must obviously be synchronized with the analyzer.

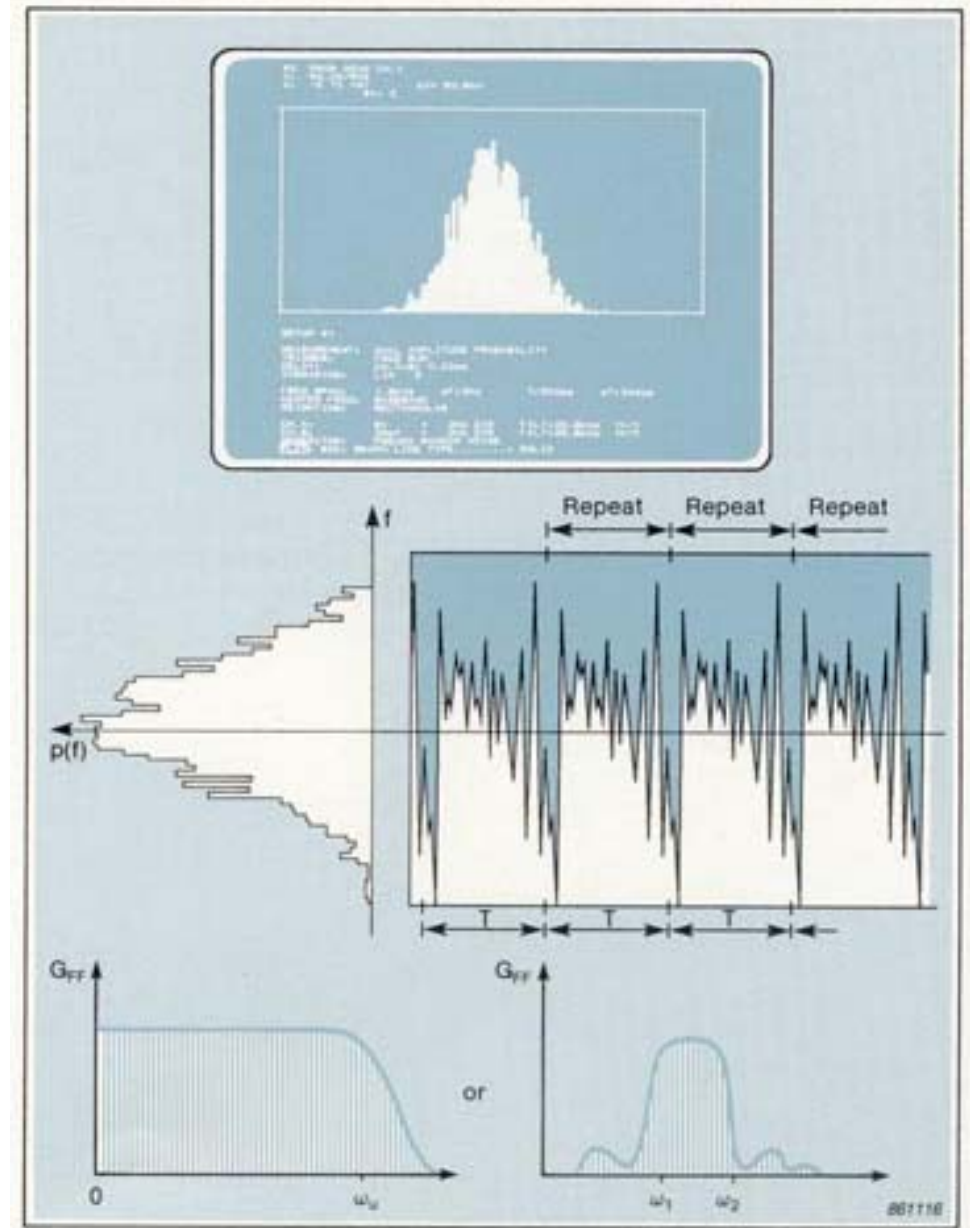

Impact Excitation

The most popular excitation technique used for modal analysis is impact, or hammer excitation.

The waveform produced by an impact is a transient (short duration) energy transfer event. The spectrum is continuous, with a maximum amplitude at 0 Hz and decaying amplitude with increasing frequency.

The spectrum has a periodic structure with zero force at frequencies at n/T intervals, where n is an integer and T is the effective duration of the transient. The useful frequency range is from 0 Hz to a frequency F , at which point the spectrum magnitude has decayed by 10 to 20 dB.

The duration, and thus the shape of the spectrum, of an impact is determined by the mass and stiffness of both the impactor and the structure. For a relatively small hammer used on a hard structure, the stiffness of the hammer tip determines the spectrum. The hammer tip acts as a mechanical filter*. Selection of the tip stiffness enables the cut-off frequency to be chosen.

*This analogy is not strictly correct since the tip does not filter out energy: it determines the frequency range where the available energy is concentrated.

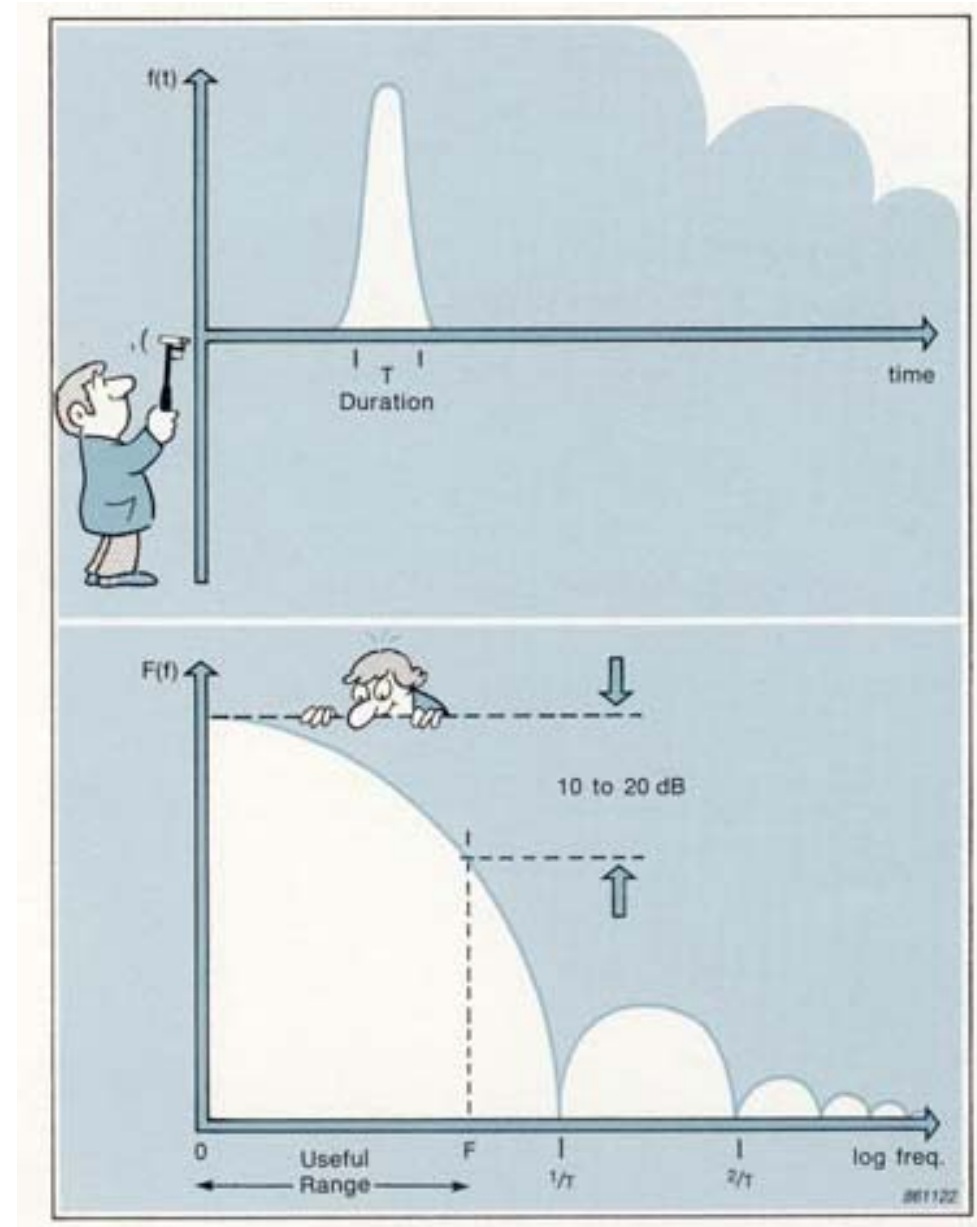

Impact hammers are constructed by adding a force transducer to a hammer, and adding a stiffness-controlling element to the end of the transducer.

Caution: The measured force is the mass of the impactor *behind* the piezoelectric disc of the force transducer, multiplied by the acceleration. The true force, exciting the structure, is equal to the total mass of the impactor (including force transducer and tip) multiplied by the acceleration during the impact. *The true force* is the measured force multiplied by the ratio of total mass/the mass behind the transducer piezoelectric.

Hammers can be constructed with weights ranging from a few grams up to several tons, covering the frequency range 0 - 5000 Hz with the smallest, and 0 - 10 Hz with the largest.

The advantages of hammer testing are:

- Speed - only a few averages are needed
- No elaborate fixtures are required.
- There is no variable mass loading of the structure. This is of particular advantage with light structures, since changing the mass loading from point to point can cause shifts in modal frequencies from one measurement to another.
- It is portable and very suitable for measurements in the field.
- It is relatively inexpensive.

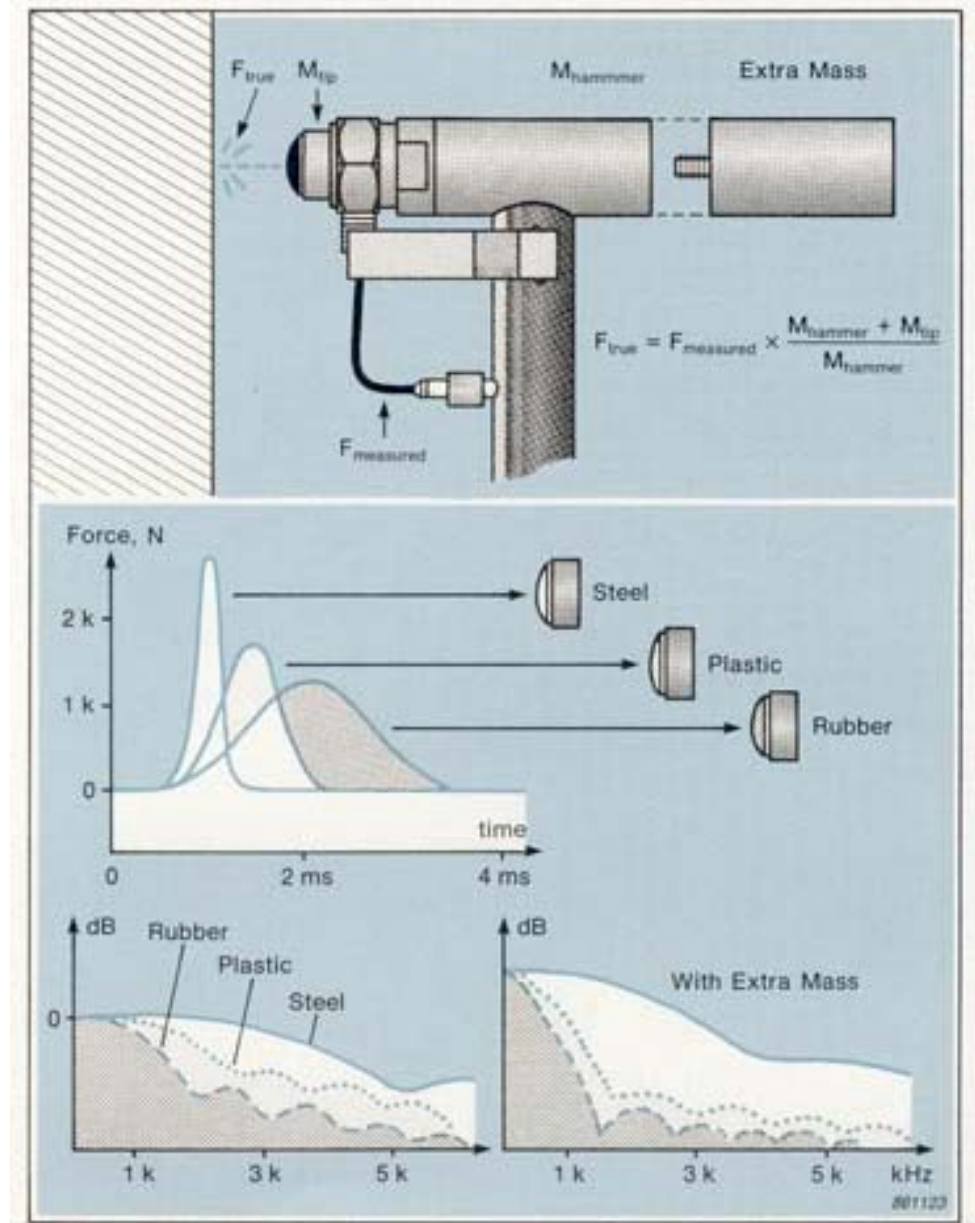

There are however some disadvantages to be considered:

- The high crest factor makes the technique unsuitable for testing systems with non-linear properties, since the non-linear behaviour will be provoked.
- To apply sufficient energy to a large structure; very high peak forces might be required, and the structure may become damaged locally.
- The signal is highly deterministic, and the force level only varies slightly between overload and trigger (underload) levels. This means that no linear approximation can be made for non-linear systems.
- Due to the deterministic nature of the signal, the Coherence Function cannot show either leakage or non-linear behaviour.
- The spectrum can only be controlled at the upper frequency limit, which means the technique is not suitable for zoom analysis.



Impact Testing and the Coherence Function

The deterministic character of impact excitation limits the use of the Coherence Function.

The Coherence Function will show a "perfect" value of 1 unless:

- There is an antiresonance, where the signal-to-noise ratio is rather poor. No particular attention needs to be paid to this. Taking a number of averages should make the FRF curve smooth (for noise at the output choose H_1).
- The person conducting the test impacts the structure in a scattered way, with respect to point and direction. This should be minimized so that the Coherence is higher than 0,95 at the resonances. If the impact point is close to a node point the Coherence may be extremely low ($\approx 0,1$). This is acceptable however, since the modal strength at this point is weak, and not important for the analysis.

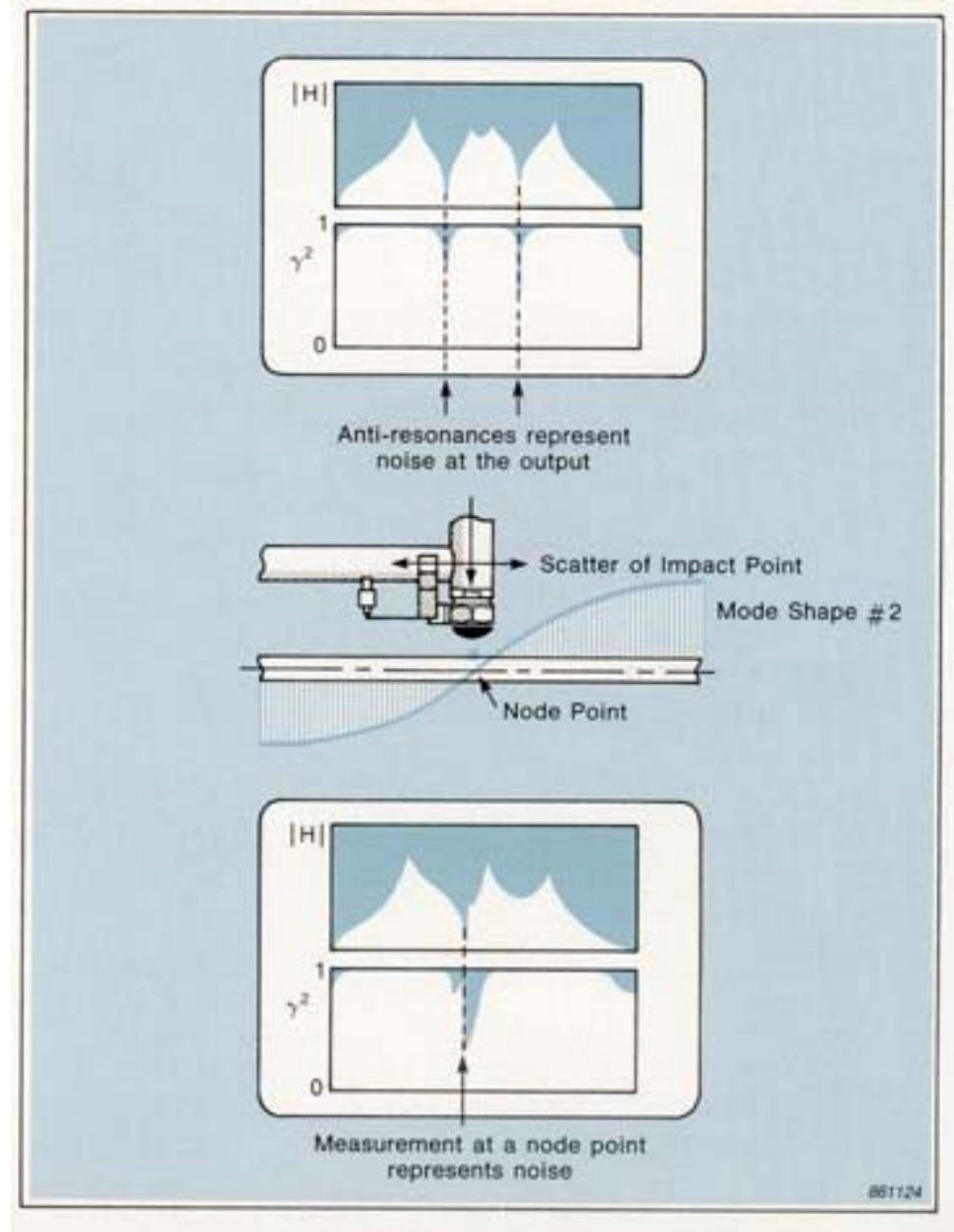

Window Techniques for Impact Testing

Before discussing window techniques for impact testing, we will review two important relationships in spectral analysis.

• Time-frequency relation

Data can normally be presented in two different domains, time or frequency. The same information is given, but is represented differently. Remember that a wide event in one domain is narrow in the other:

- Short pulses have a wide spectrum from 0 Hz up to very high frequencies.
- A continuous sinusoid has only one line in a spectrum.
- A sharp resonance rings for a long time when excited.

• Truncation-leakage relation

When the observation width is limited in one domain, the record is truncated, and a corresponding leakage is introduced in the other domain:

- If we try to measure a sharp pulse, using instrumentation which has insufficient bandwidth, then the pulse appears to be broader than it is.
- When a decaying resonance is measured using an observation time shorter than the decay time, the observed resonance peak is too broad.

Leakage introduces a non-linear error related to the record length of the Discrete Fourier Transform. This is an inherent property and it is not related to the implementation.

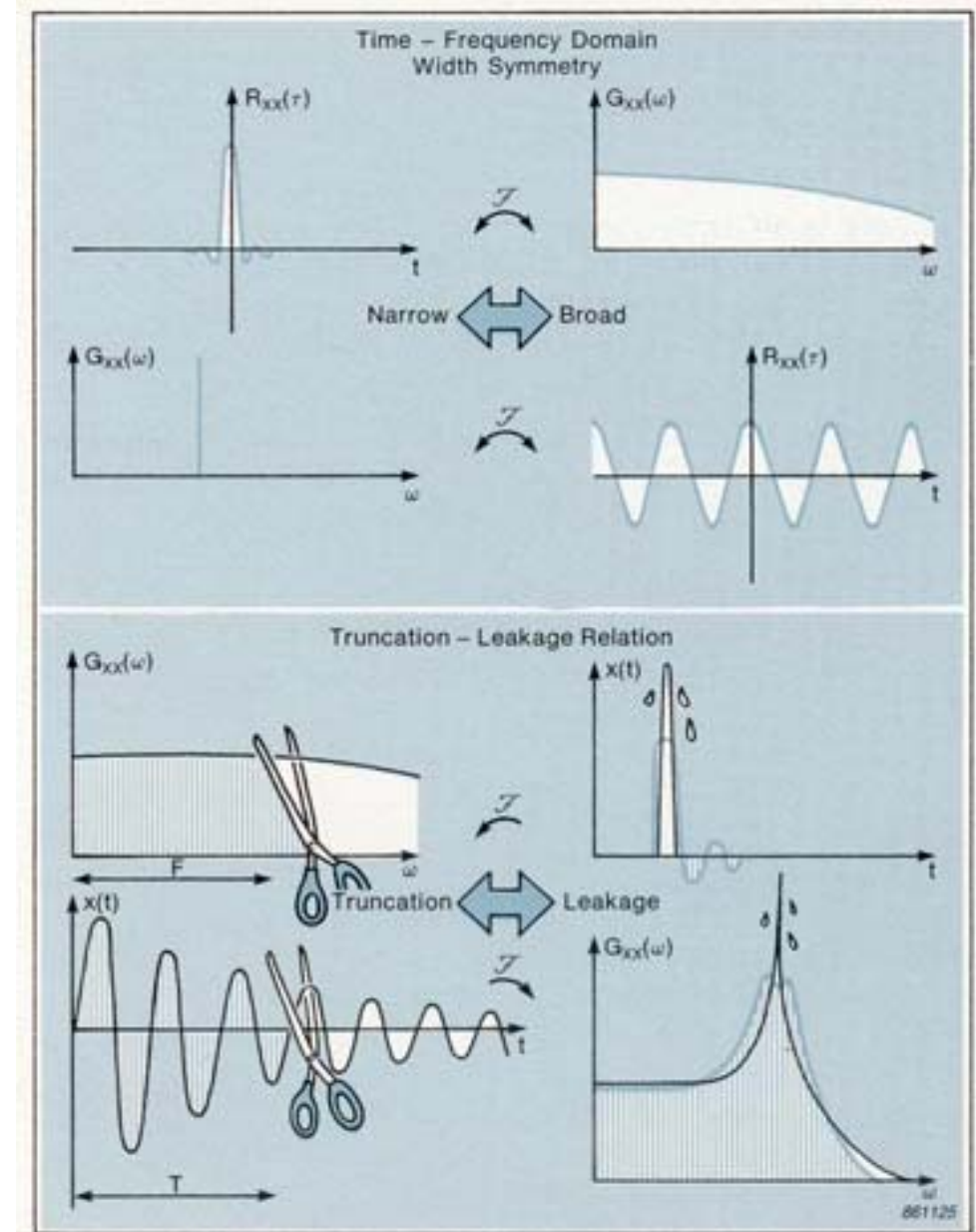

The Transient Window

The duration of an impact is usually very short compared to the record length. Special consideration must therefore be given to the application of windows.

It is the force signal during the period of impact which is of interest; the remaining signal is noise. This could be electrical noise, or vibration in the hammer itself after impact.

The window to use is the transient window. This takes the data unweighted during the period of contact, and sets it to zero for the remaining record. The window can include soft transitions, at the leading and trailing edges, to improve the smoothing when the force signal contains a DC component.

When we look at the time history of the impact force, negative signals can be observed. In a physical sense this is prohibited, but since we are measuring the force within a limited frequency range (truncation), this short "ringing" is a correct representation in the particular frequency range (leakage). The length of the force window must be chosen so that the entire signal is included.

• Double hits

If the hammer is too heavy, the structure may rebound at the hammer producing double impacts. The occurrence of double hits also depends on the skill of the experimentalist. A double hit cannot be used since the spectrum will contain zeros with a spacing of π/t_r , where n is an integer and t_r is the time delay between the dual impacts.

Double hits cannot be compensated for by using the transient window, and any Frequency Response Functions measured with a double hit will be *erroneous and must be excluded from the data set*.

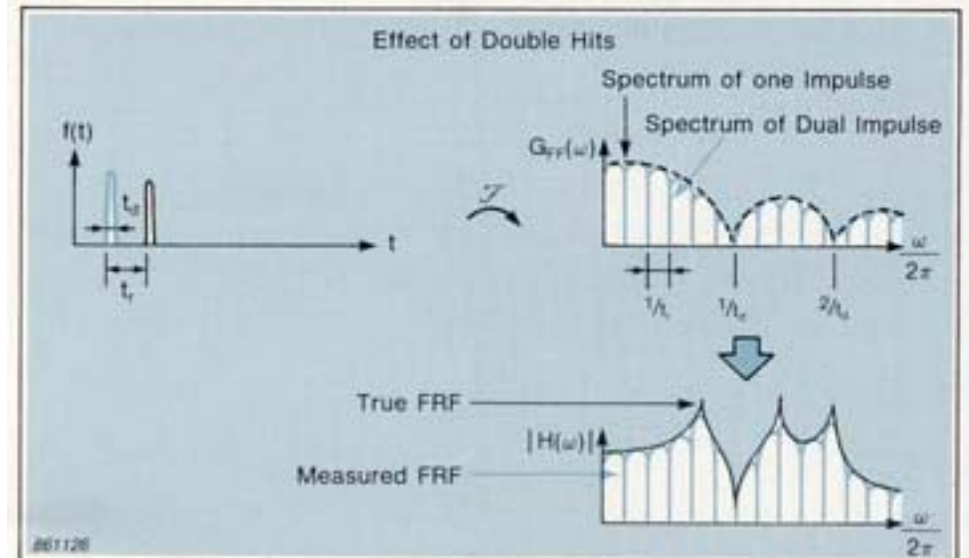
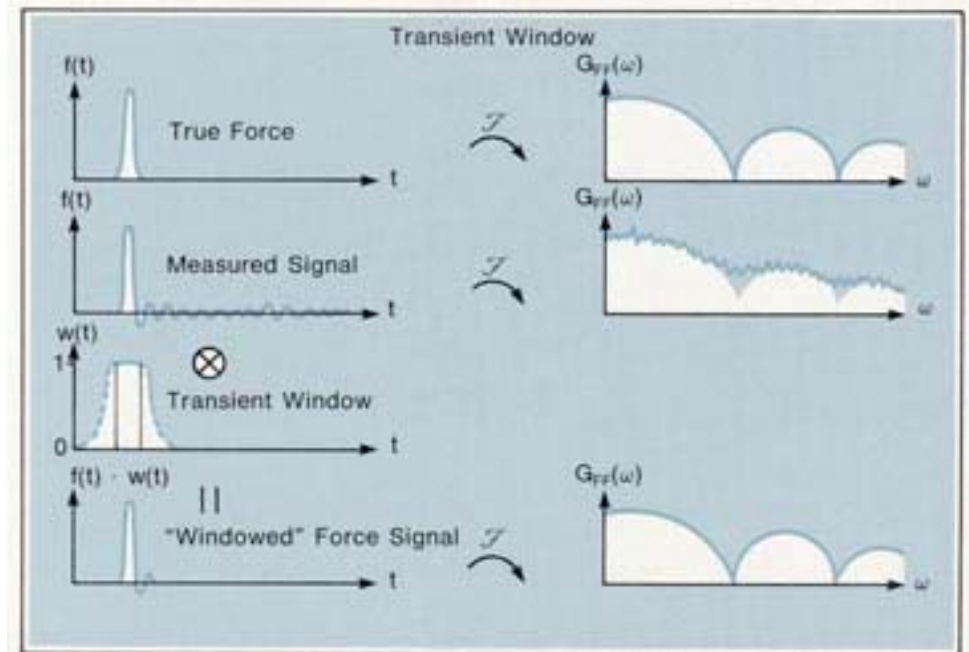

The Response Window

The response to an impact is a free decay of all the modes of vibration. Consider two typical situations:

- A lightly damped structure giving sharp resonances that ring for a long time (narrow in frequency, broad in time). If the record length is shorter than the decay time, the measurement will exhibit a leakage error (truncation in time, leakage in frequency) resulting in the observed resonances being too low and too broad.
- A heavily damped structure, where the response decays very fast and has zero response after a very short time. If the record length is much longer than the decay time there will be a poor signal-to-noise ratio, and the measurement will be contaminated by noise.

The *exponential window* will handle both situations equally well. It is a function $w(t) = e^{-t/\tau}$ which adds decay to the response, with the following effect:

- For the lightly damped structure the response is forced to decay completely within the record, so leakage due to truncation is avoided. The observed effect on the measurement is that the resonance becomes too broad, or the apparent damping is too high. A damping correction can easily be applied at the post-processing stage.
- For the heavily damped structure, the noise is attenuated by the window. A damping correction is not required since the natural decay is generally much faster than that of the window function.

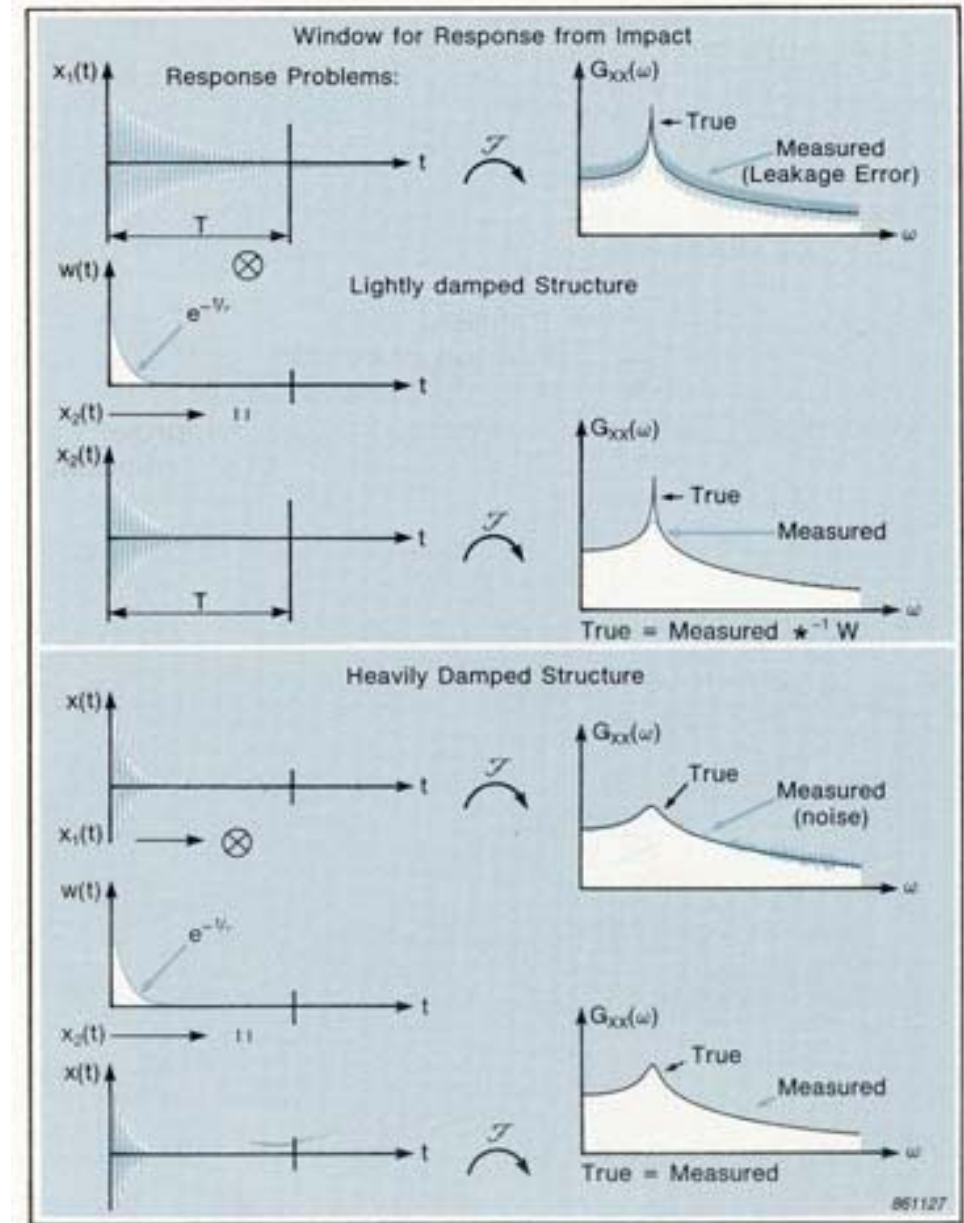

Comparison between Excitation Forms

Besides the three excitation forms already discussed, there are numerous others, examples of which are:

- *Chirps* or *fast sine sweeps*, which combine the advantage of amplitude control from sinusoidal excitation, with the speed from the wideband methods.
- *Periodic random* and *burst random*. Both take advantage of the random amplitude and phase for the randomization of non-linear behaviour, and their periodic waveform avoids leakage errors.

- *Random repeated impacts* for low frequency work (time records longer than 2 s) improve the signal-to-noise ratio. This uses the same analysis technique as for the random waveform, but maintains the ease of the hammer method.

Waveform	Analysis Speed	Leakage Error ?	Linear Approximation ?	Crest Factor S/N Ratio	Spectrum Control	Zoom Analysis ?	γ^2 -detects non-linearities ?	γ^2 -detects leakage ?	
Sinusoidal	very slow	yes	no	good	high	yes	no	no	
Random	slow	yes	yes	fair	high	yes	yes	yes	
Pseudo Random	fast	no	no	fair	high	yes	no	no	
Impact	fastest	no (with exp. window)	no	poor	limited	no	no	no	
Multiple Impact	slow	yes	some	poor-fair	limited	no	(yes)	yes	

Calibration

Most commercial transducers are supplied with calibration certificates, but a calibration test before every mobility measurement is strongly recommended, for the following reasons:

- To check the integrity of the transducers, and to detect any errors in the cables, connectors, conditioning and analyzer.
- To check that all gain, polarity and attenuator settings in the system are correct. In long measurement chains, one setting can easily be forgotten.
- To check that the pair of transducers being used, are matched in the frequency band of interest.

One way to calibrate the entire system is to measure the mobility of a simple structure. The easiest structure to use is a known mass.

From Newton's second law:

$$\text{force} = \text{mass} \times \text{acceleration}$$

it is seen that the acceleration:

$$A(\omega) = \frac{\text{acceleration}}{\text{force}} = \frac{1}{\text{mass}}$$

For any frequency the acceleration has an amplitude of $1/\text{mass}$ and a phase of 0 degrees.

A known mass suspended so that it moves in only one direction, with an accelerometer attached to detect the motion, can be used for either hammer or vibration exciter techniques. This gives a ratio calibration, ensuring correct mobility measurements, rather than an absolute calibration of the individual transducers. For this purpose, even a hand-held mass is adequate.

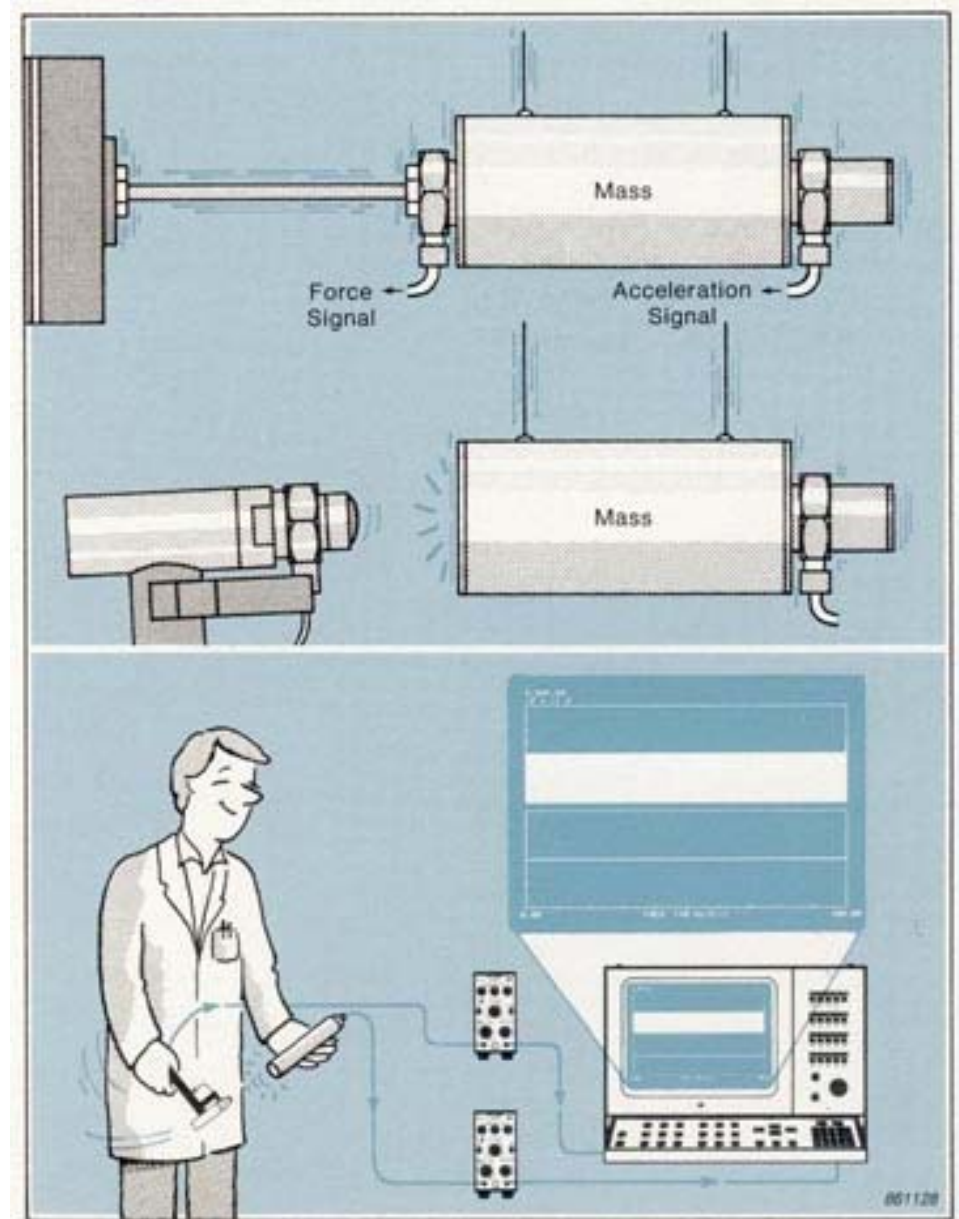

• Comments on impact calibration

If the calibration mass is considered to be absolutely rigid, in the frequency range of interest, the force and acceleration waveforms are equal.

If both a force window and an exponential response window are used, the apparent sensitivity of the response is less than the theoretical response. This is due to attenuation caused by the exponential window, but is nevertheless the correct sensitivity calibration for the complete measurement chain.

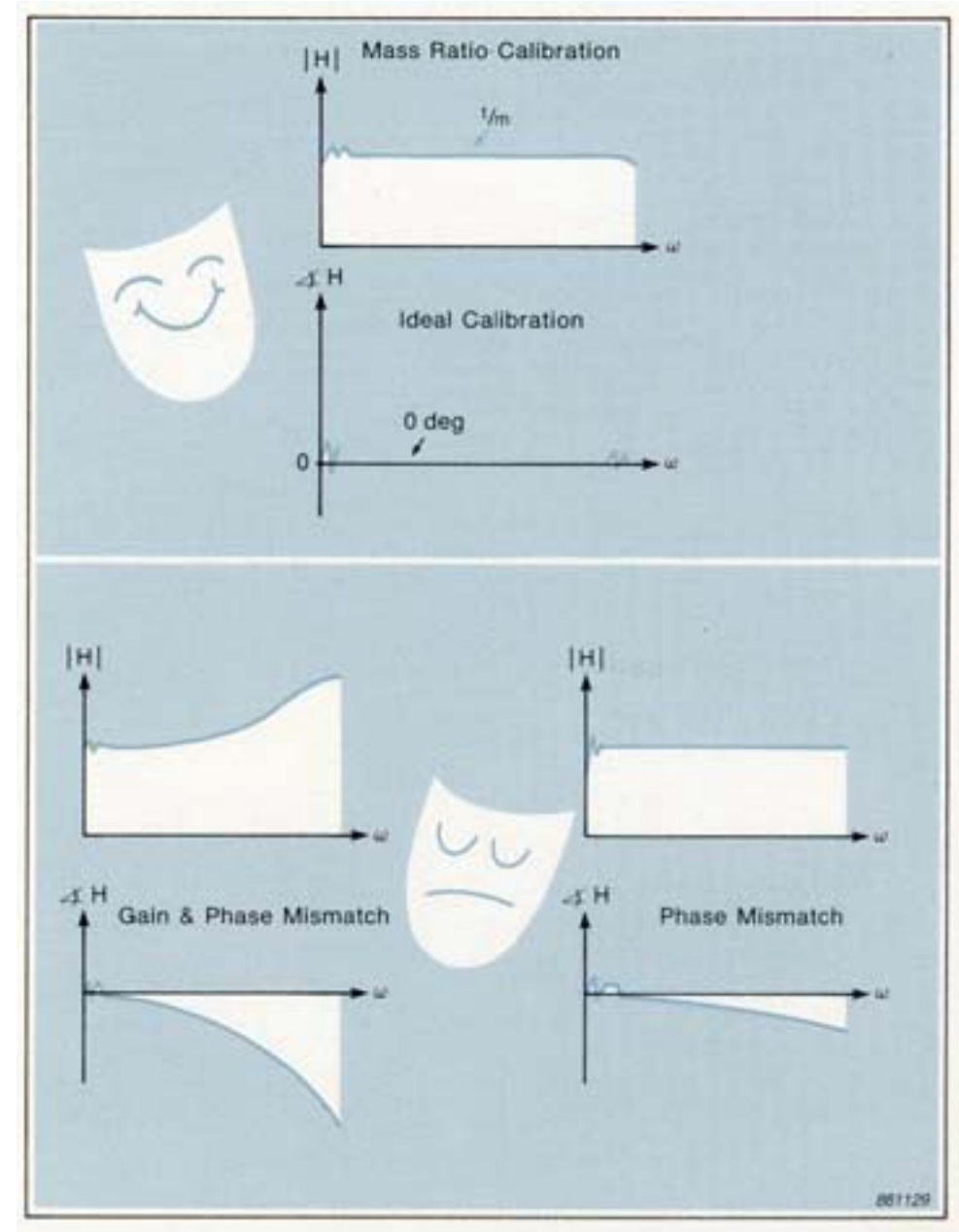

Case History: Vibrations in a Gantry Crane

• Problem

Very heavy vibrations were occurring in the crane's gantry structure during operation. The production management were in a great dilemma, a production stoppage for investigation and remedial action would be very costly, while a breakdown would be catastrophic.

• Source identification

The vibrations were only present when a particular winch unit was involved in a hoisting operation. From a few vibration measurements, the source was easily identified as the gearbox in that unit. Spectrum analysis of measurements on the gearbox showed that the predominant vibration frequency was 11 Hz. This frequency was, in turn, traced to the intermediate gearwheel, corresponding to its rotational frequency.

• Problem identification

The problem now was: were the force levels generated by the gearbox too high? Or was it a normal force level amplified by a resonance in the structure?

To determine the answer, a driving point mobility measurement was made at the shaft bearing of the gearwheel in question. Excitation by a large impactor on the top of the gearbox made the measurement both fast and easy.

The FRF showed no resonance at the observed vibration frequency of 11 Hz, and the source was diagnosed to be forced vibrations due to rotating unbalance.

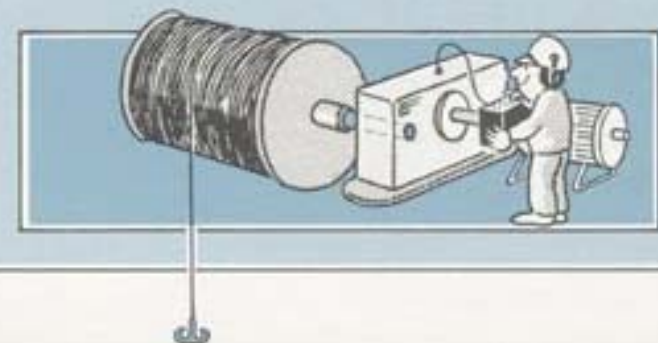
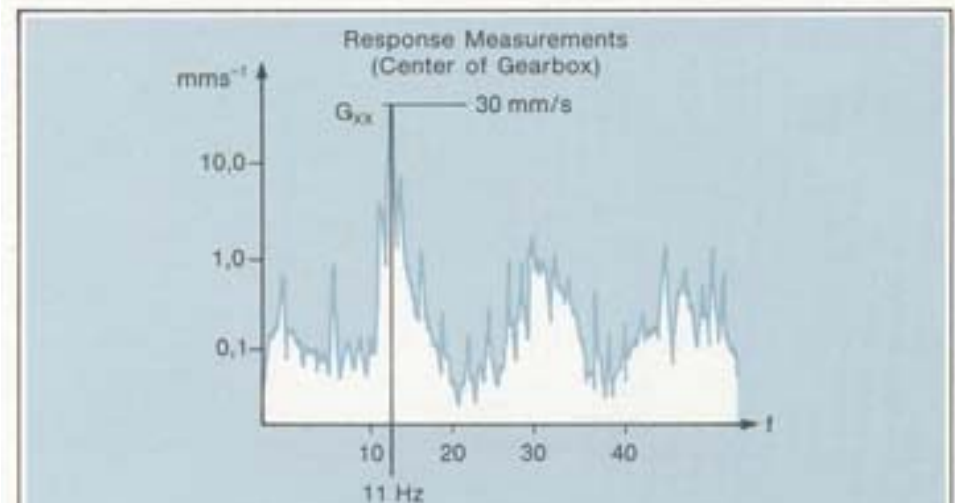
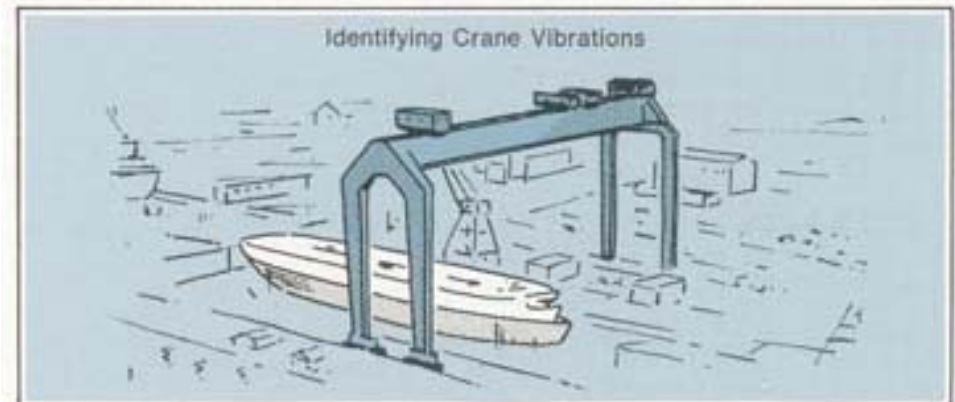

• **Determination of the unbalance forces**

A straightforward technique was applied to determine the mass unbalance forces. Treating the shaft bearing as a single input - single output system, we can rewrite our linear model:

$$F(\omega) = \frac{X(\omega)}{H(\omega)}$$

This was solved for the magnitudes, at the frequency of 11 Hz. The unbalance force magnitude was found to be 8,29 kN. A further calculation showed that this was equal to a mass moment of 1,74 kg m.

• **Solution**

A balancing shop was alerted, and production work was planned to proceed without crane operations during one working shift. The gearbox was dismantled and the gear-wheel transported to and from the balancing shop. Everything was remounted and ready for trouble-free operation within eight hours. An interesting point is that, although the assumption of a single input - single output model is coarse, the predicted mass moment of the unbalance was almost exact. It had been caused by a fracture discharging a piece of the casting, the weight of the fragment was 3,3 kg, and its centre of gravity was 0,53 m from the centre of the shaft.

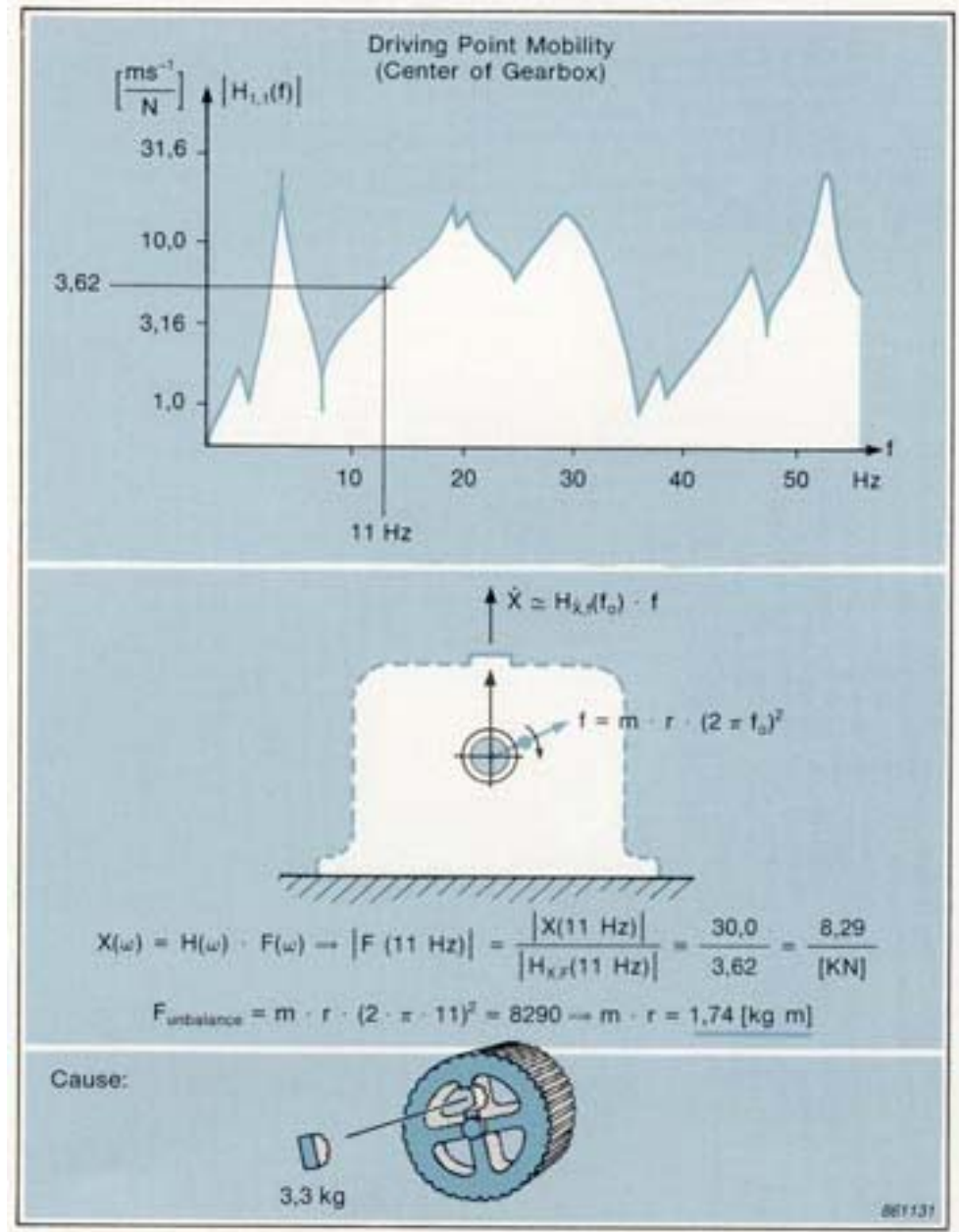

**Brüel & Kjær
2850 Nærum
Denmark**

Brüel & Kjær 

DK-2850 Nærum · Denmark · Telephone: +45 280 0500 · Telex: 37316 bruka dk · Fax: +45 280 1405